

Overview

HP Engage One AiO System , Models 141, 143, & 145

FRONT VIEW



1. 14-inch diagonal display panel (wide-aspect ratio); FHD 1920 x 1080 resolution Projected Capacitive Touch Screen
2. HP Engage One AiO System Integrated Column Printer
3. Choice of 2 Engage One I/O Connectivity Bases
4. HP Engage One AiO System Integrated MSR
5. Recessed Power Button

Overview

REAR VIEW

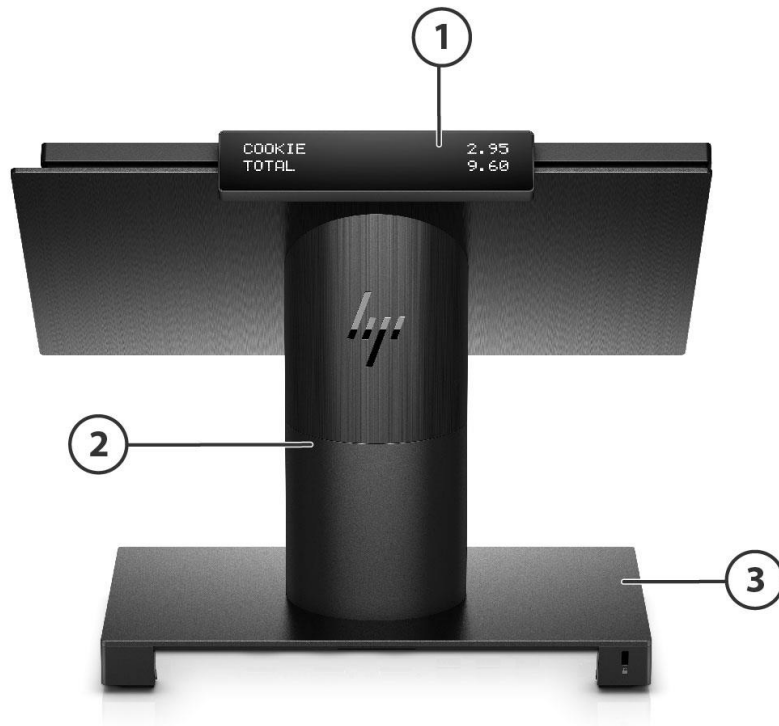

REAR VIEW

1. HP Engage One AiO System Top Mount 2x20 Customer-facing Display (CFD)
2. Rotate/Tilt Stand (Fixed Position Stand Available)
3. Choice of 2 Engage One AiO System I/O Connectivity Bases

Overview

HP Engage One AIO System Basic I/O Connectivity Base (Rear/Side View)

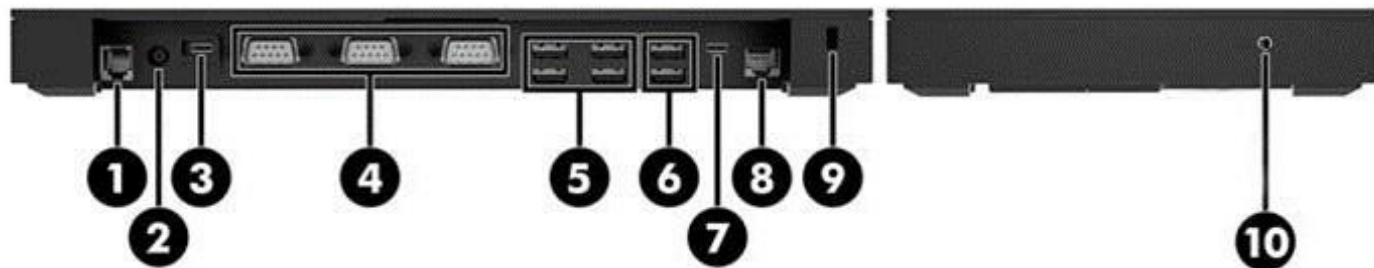

Basic I/O Connectivity Base components

- | | |
|-------------------------------------|--------------------------------|
| 1. Cash drawer jack | 7. USB Type-C™ port- Video Out |
| 2. Power connector | 8. RJ-45 network jack |
| 3. USB Type-C™ power port-Head unit | 9. Security cable slot |
| 4. Powered serial ports (3) | 10. Headset jack |
| 5. USB 2.0 ports (4) | |
| 6. USB 3.0 ports (2) | |

IMPORTANT: To avoid damage to the computer, DO NOT plug a telephone cable into the cash drawer jack.

Overview

Advanced I/O Connectivity Base* (Rear/Side View)

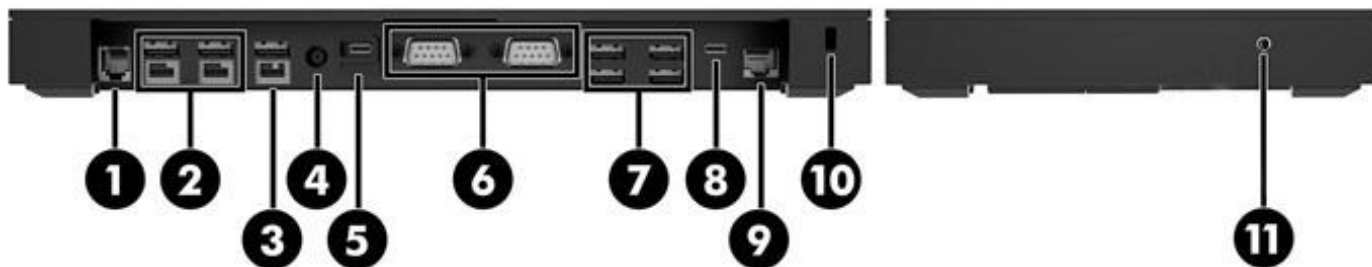

Advanced I/O Connectivity Base components

- | | |
|-------------------------------------|-------------------------------|
| 1. Cash drawer jack | 7. USB 3.0 ports (4) |
| 2. Powered USB 12 V ports (2) | 8. USB Type-C™ port-Video Out |
| 3. Powered USB 24 V port | 9. RJ-45 network jack |
| 4. Power connector | 10. Security cable slot |
| 5. USB Type-C™ power port-Head unit | 11. Headset jack |
| 6. Powered serial ports (2) | |

IMPORTANT: To avoid damage to the computer, **DO NOT** plug a telephone cable into the cash drawer jack.

* Available November 2017

Component Breakdown

Overview

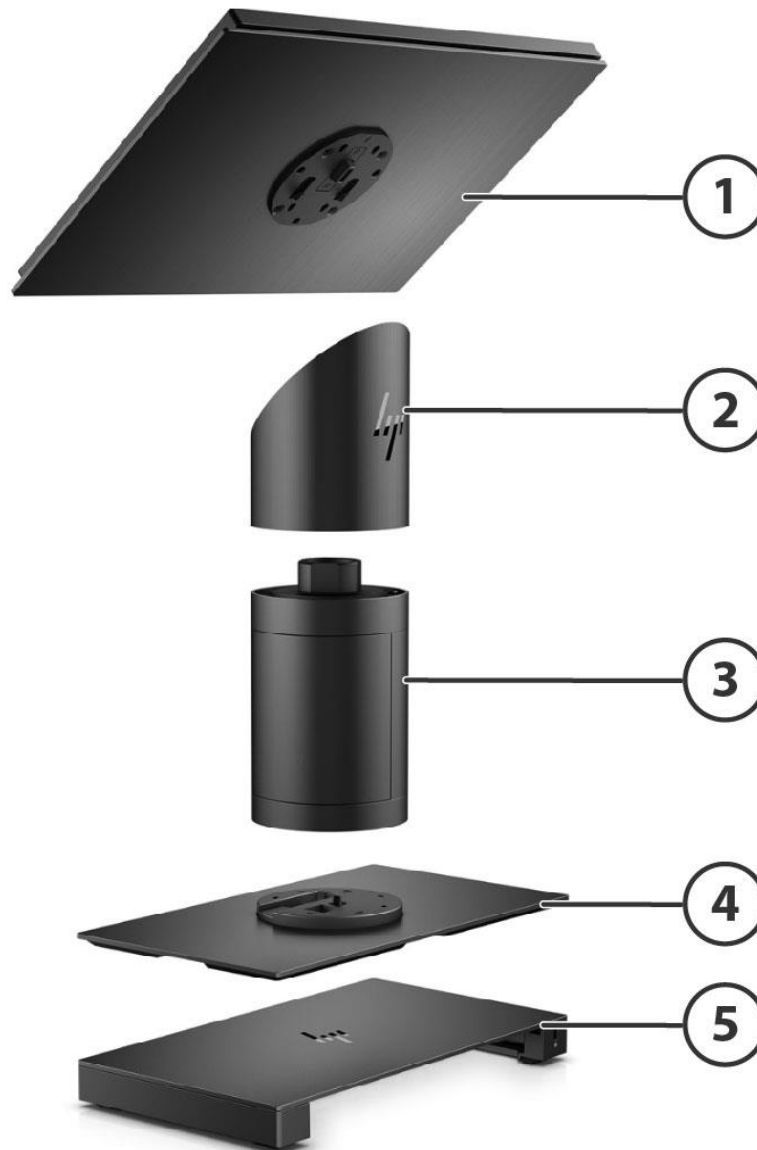

Component Breakdown

- | | |
|---|---|
| 1. Head unit: Choice of Model 141 (Intel® Celeron® 3965U), 143 (Intel® Core™ i3 - 7100U) or 145 (Intel® i5 -7300U)* | 4. Stability Base Plate |
| 2. Fixed Position or Swivel & Tilt stand or No Stand Option | 5. Connectivity Base: 2 Options based on I/O requirements |
| 3. Optional Integrated Printer or Stand Spacer | |

Not shown: Stand connects through a Single USB-C™ Cable with secure latching to connectivity base (Refer to page xxx)

Overview

Stand Options



1. HP Engage One AiO System Rotate/Tilt Stand with Integrated Column Printer
2. HP Engage One AiO System Rotate/Tilt Stand
3. HP Engage One AiO System Fixed Position Stand

NOTE: The stands are shown on a [Stability Base Plate](#).

Stand Configurations



HP Engage One AiO System No Stand Option - Display Head Only (Includes 100mm VESA Mounting Bracket)



HP Engage One AiO System Fixed Position Stand with Stability Base Plate



HP Engage One AiO System Fixed Position Stand Counter Mount -No Base Plate-includes Counter Mounting Bracket

Overview



HP Engage One AiO System Rotate/Tilt Stand with Stability Base Plate



HP Engage One AiO System Rotate/Tilt Counter Mount No Base Plate/includes Counter Mounting Bracket



HP Engage One AiO System Rotate/Tilt Stand with Integrated Printer and Stability Base Plate



HP Engage One AiO System Rotate/Tilt Stand with Integrated Printer and No Base Plate-includes counter mount

NOTE:The mounting bracket requires an 80 mm hole in the countertop. The thickness of the countertop must be 10mm to 50 mm.

Overview

At A Glance

- Choose one of the base unit models:
 - Model 141: Intel® Celeron® 3965U 2.2GHz 2M 2133 2C6 processor
 - Model 143: Intel® Core™ i3 - 7100U 2.40GHz 3M 2133 2C6 processor*
 - Model 145: Intel® i5 -7300U 2.60GHZ 3MB 2133 2C6 processor*
- Choose one of the display solutions:
 - Anti-Glare WLED SVA 300-NIT panel with FHD 1920X1080 Resolution
 - Anti- Glare WLED UWVA 500-NIT panel with FHD 1920X1080 Resolution
- Select color of system and peripherals
 - Ebony Black
 - Ceramic White
- Long lifecycle performance All-in-One (AiO) Retail System for retail and hospitality markets Choice of operator display:
 - 14" diagonal Wide Aspect ratio Projected Capacitive display; Full HD SVA 1920 x 1080 Resolution, Anti-glare
 - 14" diagonal Wide Aspect ratio Projected Capacitive display; Full HD UWVA 1920 x 1080 Resolution, Anti-glare*
- Processor choices:
 - Intel® Core™ i5-7300U with vPro¹ (2.6GHz, 3M Cache, 2 Cores)*
 - Intel® Core™ i3-7100U (2.4GHz 3M Cache, 2 Cores)*
 - Intel® Core™ Celeron® 3965U (2.2GHz, 2M Cache, 2 Cores)
- Operating System choices:
 - Windows 10 Professional 64-bit
 - Windows 10 IoT Enterprise 2016 LTSB 64-bit
 - FreeDOS 2.0
- Connectivity Base Choices
 - HP Basic I/O Connectivity Base
 - HP Advanced I/O Connectivity Base
 - HP USB-C Mini Dock
- Integrated peripheral options (can also be purchased and installed separately except for the HP Engage One AiO System MSR & HP HP Engage One AiO System Column Printer which are configurable options):
 - HP Engage One MSR
 - HP Engage One Column Printer
 - HP Engage One Fingerprint Reader
 - HP Engage One Top Mount 2x20 CFD
- Industry-standard 100mm VESA mounting pattern allows for flexible use without the optional stand (Mounting hardware sold separately)
- Choice of Fixed Position Stand, Rotate/Tilt Stand that allows for 10° angle adjustability & 180-degree rotation left or right, or no stand (display – head unit only) which includes 100mm VESA Mounting Bracket
- (2) Two DDR4 Memory Slots (32 GB Maximum)
- Realtek RTL8153 Ethernet Connection
- Intel & Realtek WLAN Options
- Trusted Platform Module (TPM 2.0)
- HP BIOSphere with HP Sure Start technology
- (1) M.2 drive bay
- Cable Management Features
- ENERGY STAR® certified configurations available, EU Compliant, RoHS2 Compliant, EPEAT® Silver registered configurations available
- Basic Retail I/O connectivity Base: 120W, 88% efficient, active PFC (external)
- Advanced Retail I/O connectivity Base: 180W or 200W, 89% efficient, active PFC (external)
- Display Head unit Only 65W, 89% efficient at 20V, active PFC (external)
- Standard Warranty Options – 90/90/90, 1/1/1, 3/3/3; Plus Optional Care Packs

1. vPRO is only supported on model 145 (Intel Core i5 processor) in wireless mode, when configured with the Intel WLAN 8265 with vPRO Card

NOTE: See important legal disclosures for all listed specs in their respective features sections.

Standard and Configurable Components

OPERATING SYSTEM

Preinstalled	Windows 10 Professional 64-bit Windows 10 IoT 64 Enterprise LTSC 2019 Windows 10 IoT Enterprise 2016 LTSB 64-bit FreeDOS 2.0
Certified	SuSE Linux® 12 SP3**

NOTE: In accordance with Microsoft's support policy, HP does not support the Windows 8 or Windows 7 operating system on products configured with Intel® 7th generation and forward processors or provide any Windows 8 or Windows 7 drivers on <http://www.support.hp.com>

* Not all features are available in all editions or versions of Windows. Systems may require upgraded and/or separately purchased hardware, drivers, software or BIOS update to take full advantage of Windows functionality. Windows 10 is automatically updated, which is always enabled. ISP fees may apply and additional requirements may apply over time for updates. See <http://www.microsoft.com>

** SUSE YES Certification is planned for late CY17 on a single platform configuration. More information about SUSE YES certification on <https://www.suse.com/partners/ihv/yes/>

The following features are not supported by SUSE Linux Enterprise Desktop:

- Power Management features
- Multi-touch capabilities
- Systems configured with Linux do not qualify for ENERGY STAR®

PROCESSORS

Model 143 & 145***

- Intel® Core™ i5-7300U with vPro^{1,2} (2.6GHz, 3M Cache, 2 Cores)
- Intel® Core™ i3-7100U (2.4GHz 3M Cache, 2 Cores)

Model 141

- Intel® Core™ Celeron® 3965U (2.2GHz, 2M Cache, 2 Cores)

NOTE: Core™ i5 Turbo Boost technology – performance can be increased through the BIOS

***NOTE:** In accordance with Microsoft's support policy, HP does not support the Windows 8 or Windows 7 operating system on products configured with Intel® 7th generation and forward processors or provide any Windows 8 or Windows 7 drivers on <http://www.support.hp.com>

****NOTE:** Multi-Core is designed to improve performance of certain software products. Not all customers or software applications will necessarily benefit from use of this technology. Performance and clock frequency will vary depending on application workload and your hardware and software configurations. Intel's numbering, branding and/or naming is not a measurement of higher performance.

***Available November 2017

1. vPRO is only supported on model 145 (Intel Core i5 processor) in wireless mode, when configured with the Intel WLAN 8265 with vPRO Card

Standard and Configurable Components

2. Some functionality of vPro, such as Intel Active management technology and Intel Virtualization technology, requires additional 3rd party software in order to run. Availability of future "virtual appliances" applications for Intel vPro technology is dependant on 3rd party software providers. Compatibility with future "virtual appliances is yet to be determined.

Standard and Configurable Components

CORE™ vPRO™ PROCESSORS

INTEL® 7th GENERATION CORE™ vPRO™ PROCESSORS

The HP Engage One AiO System Retail System features this technology, and includes processors that are part of the Intel® Stable Image.

Platform Program (SIPP) designed to ensure the stability promise inherent in the value proposition of the HP Engage One AiO System Retail System. This makes these models the most stable, secure, and manageable platforms available to retailers today.

Intel® Advanced Management Technology (AMT) v11.6+ – An advanced set of remote management features and functionality which provides network administrators the latest and most effective tools to remotely discover, heal, and protect networked client systems regardless of the system's health or power state. AMT 11.6+ includes the following advanced management functions:

- Power Management (on, off, reset)
- Hardware Inventory (includes BIOS and firmware revisions)
- Hardware Alerting
- Agent Presence
- System Defense Filters
- SOL/USBR
- Cisco NAC/SDN Support
- ME Wake-on-LAN
- DASH 1.1 compliance
- IPv6 Support
- Fast Call for Help - a client inside or outside the firewall may initiate a call for help via BIOS screen, periodic connections, or alert triggered connection
- Remote Scheduled Maintenance - pre-schedule when the PC connects to the IT or service provider console for maintenance. Remote PCs can get required patches, be inventoried, etc. by connecting to their IT console or Service Provider when it's convenient.
- Remote Alerts - automatically alert IT or service provider if issues arise
- Access Monitor - Provides oversight into Intel® AMT actions to support security requirements
- PC Alarm Clock
- Microsoft NAP Support
- Host-based set-up and configuration
- Management Engine (ME) firmware roll back
- Wireless AMT functionality on Desktop (WoDT)
- Enhanced KVM resolution

*Some functionality of this technology, such as Intel Active management technology and Intel Virtualization technology, requires additional 3rd party software in order to run. Availability of future "virtual appliances" applications for Intel vPro™ technology is dependent on 3rd party software providers. Compatibility with future "virtual appliances" is yet to be determined.

** Intel® Active Management Technology requires an Intel® AMT-enabled chipset, network hardware and software, as well as connection with a power source and a corporate network connection. Setup requires configuration by the purchaser and may require scripting with the management console or further integration into existing security frameworks to enable certain functionality. It may also require modifications of implementation of new business processes.

CHIPSET

Intel® Multi-Chip Package – MCP

Standard and Configurable Components

HP BIOS

Key features of the HP BIOS include:

- Deployment and manageability – HP BIOS provides several technologies that help integrate the HP Engage One AiO System G1 Retail System into a business environment, such as PXE, remote configuration, remote control, and F10 Setup support for 14 languages.
- Update your BIOS via the cloud or standardize on a BIOS version hosted on Enterprise network.
- Select models feature either Intel® Standard Manageability or Intel® Core™ vPro™¹ Processor Technology.
- Stability – HP BIOS supports the HP stable product roadmap by releasing only critical BIOS changes to the factory and advanced change notification.
- UEFI specification 2.5
- Absolute Persistence agent – For tracking and tracing services, available in select countries, separate software and purchase of a subscription is required.
- Thermal and power management – The HP BIOS provides and enables thermal and power management technologies so component temperatures are managed for high reliability and to assist in operating the HP Engage One AiO system in any retail environment.
- Acoustic performance – Industry leading acoustic emissions across the range of operating conditions.
- Serviceability – HP BIOS provides diagnostic and detailed service information.
- Upgrades and recovery – HP BIOS provides numerous ways to update the HP Engage One AiO System, using a host-based Windows application, various remote deployment tools (HP Client Manager, HP Software Support Manager, scheduled network updates, and fail-safe recovery). In addition, the HP Engage One AiO System system supports management tools for replicating BIOS settings throughout the Enterprise, either host-based software (HP BIOS Configuration Utility), 3rd party remote management tools such as SCCM, or manually using USB.
- HP BIOS uses PKI signing of the BIOS for trusted BIOS upgrades and recovery.

Additional HP BIOS Features:

- Power-On password – Helps prevent an unauthorized user from powering on the system.
- Administrator password – Also known as the setup password, this helps prevent unauthorized changes to the system configuration. If the administrator password is not known, the BIOS version cannot be changed and changes cannot be made to BIOS settings using F10 setup or under the OS.
- Advanced Configuration and Power Interface (ACPI) – Represents a significant innovation in power and configuration management, allowing operating systems and applications to manage power based on activity and usage. The HP Engage One AiO System Retail System uses ACPI to provide power conservation features.
- S5 Max Power Savings setting supports EU Lot6 requirement and allows the computer to power down below .5W in S5 (when turned off). When S5 Max Power Savings feature is enabled power to slots is turned off along with WOL functionality and USB Charging ports.
- When the S5 Maximum Power Savings feature is enabled, only the power button will turn on the system. Other wake sources such as Wake on LAN are powered off and do not function.

Sure Start

- BIOS Integrity checking – Sure Start protection ensures that only trusted BIOS code is executed and not rootkits, viruses and malware. Verification is done upon boot up, shutdown and while on.
- Sure Start is set by default to automatically repair the BIOS if corrupted or compromised but is policy driven for better manageability.
- Protecting beyond BIOS – Integrity checking and repair is extended to other data that should be protected such as network configuration parameters (network name), platform specific information (i.e. system IDs) and other code the system needs to boot.
- Audit enabled – System Audit via Sure Start Event Logs capture data such as incident, repair date and time for troubleshooting and investigating.

Standard and Configurable Components

Security

- HP Engage One AiO System Biometric Fingerprint Reader (optional)
- Bolt to counter mechanism
- VESA mounting
- HP Engage One AiO System Keyed Cable Lock
- HP BIOSphere with SureStart Gen 3
- Device Guard²
- Credential Guard and password protection²
- Trusted Platform Module TPM 2.0 Embedded Security Chip (SLB9670 - Common Criteria EAL4+ Certified)
- Drive lock
- USB enable/disable (via BIOS)
- Power-on password (via BIOS)
- Setup password (via BIOS)
- Tamper Resistant Screw affixed on stand of the system unit, used to secure display head to stand without Quick Release
- HP Secure Erase
- HP Multi-Factor Authenticate
- HP Sure Click (Standard)³
- HP Image Assistant
- HP vPRO Support^{4,5,6}

1. vPRO is only supported on model 145 (Intel Core i5 processor) in wireless mode, when configured with the Intel WLAN 8265 with vPRO Card
2. Microsoft Device Guard and Credential Guard are available with Windows 10 IoT Enterprise 2016 delivered from HP or to customers with a volume license to use Windows 10 Enterprise. Microsoft Device Guard and Credential Guard are not available with Windows 10 Pro. The installation of Windows 10 Enterprise and Microsoft Device Guard and Credential Guard are available through HP Configuration & Deployment Services.
3. HP Sure Click is only supported on Intel Core i3, i5 and i7 and i9 processors
4. vPRO support requires either an Intel Core i5 or Core i7 processor
5. vPRO support also requires a vPRO WLAN Card for these products
6. vPRO enablement is a separate option on some products

NOTE: BIOS supports configuration on ports for the Engage One Basic I/O Connectivity Base and Engage One Advanced I/O Connectivity Base. The functionality is not supported with other products.

Standard and Configurable Components

SOFTWARE

HP Client Management Solutions (available for free download from hp.com/go/easydeploy)

HP BIOSphere with Sure Start Generation 3.0²

HP Support Assistant

Device Guard¹

Credential Guard¹

1. Microsoft Device Guard and Credential Guard are available with Windows 10 IoT Enterprise 2016 delivered from HP or to customers with a volume license to use Windows 10 Enterprise. Microsoft Device Guard and Credential Guard are not available with Windows 10 Pro. The installation of Windows 10 Enterprise and Microsoft Device Guard and Credential Guard are available through HP Configuration & Deployment Services.
2. HP Sure Start Gen3 is available on products equipped with Intel® 7th generation processors.

GRAPHICS

Intel® HD Graphics (integrated)

Integrated Graphics

Intel Integrated HD Graphics 610 (Celeron, Model 141); Intel Integrated HD Graphics 620 (Core i3, Model 143, Core i5, Model 145)

DisplayPort

Multimode capable; supports HDCP, Display Port Audio (2 streams), HBR2 link rates and Multi-Stream Technology for a maximum of 3 displays (including the integrated panel)

Memory

The BIOS has options for selecting the dedicated memory size of 128MB, 256MB or 512MB
Additional memory is allocated for graphics as needed using Intel's Dynamic Video Memory Technology (DVMT), to provide an optimal balance between graphics and system memory use.

Maximum Graphics Memory

Windows 10

>4 GB

NOTE: the actual amount of maximum graphics memory can be less than the amounts listed above depending upon your computer's configuration.

Maximum Color Depth

32 bits/pixel

7th Generation Core™ processors:

- Next Generation Intel® Clear Video Technology HD Support is a collection of video playback and enhancement features that improve the end user's viewing experience
 - Encode/transcode HD content
 - Playback of high definition content including Blu-ray Disc
 - Superior image quality with sharper, more colorful images
- DirectX Video Acceleration (DXVA) support for accelerating video processing
 - Full AVC/VC1/MPEG2/HEVC HW Decode
- Advanced Scheduler 2.0, 1.0
- Windows 10, Linux OS Support
- DirectX 12.1

Graphics/Video API Support

Standard and Configurable Components

- OpenGL 4.4
- Open CL 1.2 (Intel® HD Graphics 510)
- Open CL 1.2/2.0 (Intel® HD Graphics 530)

Standard and Configurable Components

Supported Display Resolutions and Refresh Rates

NOTE: Other resolutions may be available but are not recommended as they may not have been tested and qualified by HP

Resolution	Refresh Rates
640x480	60 Hz
800x600	60 Hz
1024x768	60 Hz
1280x720	60 Hz
1280x768	60 Hz
1360x768	60 Hz
1280x1024	60 Hz
1400x1050	60 Hz
1680x1050	60 Hz
1920x1080	60 Hz
1920x1200*	60 Hz
2048x1152*	60 Hz
2048x1280*	60 Hz
2048x1536*	60 Hz
2304x1440*	60 Hz
2560x1440*	60 Hz
3840x2160**	30 Hz
2560x1600*	60 Hz
2880x1800*	60 Hz
3200x2400*	60 Hz
4096x2160*	60 Hz
4096x2304*	60 Hz

* Only supported on displays connected to the external DisplayPort™ connector.

** 3840x2160 is not supported for Celeron series processors

Standard and Configurable Components

MEMORY

Type

DDR4-2400 Memory DIMMs, Transfer rates up to 2400 MT/s

Maximum

32 GB

of Slots

2 SODIMM

Memory Upgrades

Both slots are customer accessible / upgradeable.

- 4 GB (4 GB x 1)
- 8 GB (4 GB x 2)
- 8 GB (8 GB x 1)
- 16 GB (8 GB x 2)
- 16 GB (16 GB x 1)
- 32 GB (16 GB x 2)

System Memory Support

The HP Engage One AiO System Retail System supports DDR4 protocols with two independent, 64-bit wide channels each accessing one or two SoDIMMs.

- Two channels of non-ECC DDR4 unbuffered small outline dual in-line memory modules (SO-DIMM) with a maximum of one DIMMs per channel
- Single-channel and dual-channel memory organization modes
- Data burst length of eight for all memory organization modes
- Memory data transfer rates of up to 2400 MT/s; actual supported data transfer rate determined by the configured processor.
- 64-bit wide channels
- DDR4 system memory I/O voltage of 1.2V
- Theoretical maximum memory bandwidth of:
 - 21.3 GB/s in dual-channel mode assuming 1333 MT/s
 - 25.6 GB/s in dual-channel mode assuming 1600 MT/s
 - 34.0 GB/s in dual-channel mode assuming 2133 MT/s
 - 38.4 GB/s in dual-channel mode assuming 2400 MT/s

Key Benefits of DDR4 Memory:

- Dual channel configuration – HP Engage One AiO System features motherboards designed with two memory channels instead of a single channel.
- Reduce system latencies and significantly improve your system performance with dual channel memory configurations by utilizing the theoretical bandwidth of two memory modules instead of one.
- Expect fast start-up times with reduced delays during routine operations and system maintenance functions. Meet everyday workloads head on, and run more programs simultaneously. Easily toggle back and forth between several open applications with noticeable speed.

NOTE: For systems configured with more than 3 GB of memory and a 32-bit operating system, all memory may not be available due to system resource requirements. Addressing memory above 4 GB requires a 64-bit operating system.

Memory modules support data transfer rates up to 2400 MT/s; actual data rate is determined by the system's configured processor. See processor specifications for supported memory data rate.

CAUTION: You must shut down the Retail System and disconnect the power cord before adding or removing memory modules. Regardless of the power-on state, voltage is always supplied to the memory modules as long as the Retail System is plugged in to an active AC outlet. Adding or removing memory modules while voltage is present may cause irreparable damage to the memory modules or system board.

Standard and Configurable Components

HARD DISK AND SOLID STATE STORAGE

Drive Bays

1 (one) M.2 SSD Bays

- SATA
- PCIe (NVME)

M.2 Storage:

M.2 SATA

128GB M2 SATA-3 TLC
256GB M2 SATA-3 TLC SSD
512GB M2 SATA-3 TLC SSD
512GB Turbo Drive G2 MLC SSD

NVMe

128GB TLC 6000p SSD
256GB PCIe NVMe TLC SSD
256GB TLC Pro 6000p SSD
512GB PCIe NVMe TLC SSD
512GB TLC Pro 6000p SSD
1TB PCIe-3x4 NVMe TLC SSD

Standard and Configurable Components

OPERATOR DISPLAY

14" Diagonal Wide-Aspect Operator Value Display (Model 141), Anti-Glare WLED SVA

Touch Technology	Projected Capacitive Touchscreen
Resolution	1920 x 1080
Aspect Ratio	16:9
Max Color	262K
Brightness	Typical 300 nits (LCM)*
Contrast Ratio	Typical 300:1*
Pixel Pitch	160.86 um x 160.86 um
Viewing Angle	Horizontal 90°, Vertical 65°
Response rate	10ms (Typical On/Off)
Backlight	LED
Operating Temperature range	0 to 60°C (+ 60°C as panel surface temperature)

14" Diagonal Wide Aspect Projective Capacitive Operator Display (Models 143 & 145), Anti-Glare WLED UWVA

Touch Technology	Projected Capacitive Touchscreen
Resolution	1920 x 1080
Aspect Ratio	16:9
Max Color	262K
Brightness	Typical 500 nits (LCM)*
Contrast Ratio	Typical 800:1
Pixel Pitch	161um x 161 um
Viewing Angle	Horizontal 178°, Vertical 178°
Response rate	25ms (Typical On / Off)
Backlight	LED
Operating Temperature range	0 to 60°C (+ 60°C as panel surface temperature)

***NOTE:** Nits is the measure of the typical brightness of the panel as specified, prior to anti-glare coating

Technical Specifications - Audio

High Definition Audio*

Engage One System Audio (Realtek ALC3228)

Type	Integrated
HD Stereo Codec	ALC3228 High Definition Audio Codec
Internal Speaker Amplifier	1W amplifier for the internal speaker only.
Sampling	All DACs support 44.1k/48k/96k/192kHz sample rate All ADCs support 44.1k/48k/96k/192kHz sample rate S/PDIF-OUT support 16/20/24-bit format and 32/44.1/48/88.2/96/192kHz rate
Analog Audio	Yes
# of Channels on Line-Out	Stereo (Left & Right channels)
Internal Speaker	Yes

Advanced & Basic I/O Base (Realtek ALC4040)

Type	USB
Audio Codec	ALC4040 Audio Codec with USB to I2S audio controller and hardware active noise cancellation
Audio I/O Ports	1 headphone-out/microphone-in combo
Sampling	One I2S/PCM/TDM digital interface supports sample rates 8k, 16k, 32k, 44.1k, 48k, 96k, and 192kHz One stereo DAC supports up to 44.1, 48, and 192KHz Sample Rate, 16/24-bit One stereo ADC Input supports 44.1, 48, and 96KHz Sample Rate, 16/24-bit
Analog Audio	Yes
# of Channels on Line-Out	2
External Speaker Jack	1

NOTE(Retail Advanced & Basic Hubs Only): Audio input ports are re-taskable as a Line-in or Microphone-in port. External speakers must be powered externally. Multi-streaming can be enabled to allow independent audio streams to be sent to/from the internal speakers and headphone/Line out jack. This allows for different audio applications to use separate audio ports on the system. For example, the Headphone jack could be used with a headphone for a communications application while the internal speakers for a multimedia application.

Technical Specifications – Storage

Intel 128GB Three Layer Cell 6000p Solid State Drive

Unformatted Capacity	128 GB
Architecture	3D Tri-Level Cell (TLC) NAND
Interface	PCIe NVMe 3.0 x4
Form Factor	M.2 (80mm)
Height	Up to 1.5mm
Width	22mm
Length	80mm
Weight	Up to 40 g
Bandwidth Performance	Sustained Sequential Read: Up to 770 MB/s Sustained Sequential Write: Up to 450 MB/s Random Read Up to 40k IOPS Random Write Up to 35k IOPS
Useful Drive Life	72TB written, up to 40GB/day for 5 years
Power	Power consumption: Active: 200mW Typical Idle: 50mW Typical L1.2 Sleep 5mW Typical
Mean Time Between Failure (MTBF)	1,600,000 Hours
Environmental (all conditions, non-condensing)	Operating Temperature: 32° to 158° F (0° to 70° C) Vibrating – Operating 2.17 GRMS (5-700Hz) Max Vibrating – Non-Operating 3.13 GRMS (5-800Hz) Max

128GB Solid State M2 SATA-3 Three Layer Cell Drive

Drive Weight	0.019 lb (8.5 g)-0.022 lb (10 g)
Capacity	128 GB
Height	0.09 in (2.23 mm)- 0.14 in (3.58 mm)
Width	0.87 in (22 mm)
Interface	ATA-8, SATA 3.0
Bandwidth Performance	Maximum Sequential Read: 500 ~ 540 MB/s Maximum Sequential Write: 130 ~ 450 MB/s
Logical Blocks	250,069,680
Operating Temperature	32° to 158°F (0° to 70°C) [ambient temp]
Features	DIPM; TRIM; DEVSLP
Security Features	ATA Security

Technical Specifications – Storage

256GB M2 SATA-3 Three Layer Cell Solid State Drive

Drive Weight	0.022 lb (10 g)
Capacity	256 GB
Height	0.09 in (2.3 mm)- 0.14 in (3.58 mm)
Width	0.87 in (22 mm)
Interface	ATA-8, SATA 3.0
Bandwidth Performance	Maximum Sequential Read: 515 ~ 540 MB/s Maximum Sequential Write: 260 ~ 450 MB/s
Logical Blocks	500,118,192
Operating Temperature	32° to 158°F (0° to 70°C) [ambient temp]
Features	DIPM; TRIM; DEVSLP
Security Features	ATA Security

256GB PCIe NVMe Three Layer Cell Solid State Drive

Unformatted Capacity	256 GB
Architecture	Solid State Drive with TLC NAND Flash and PCIe interface. Complies with NVMe Standard Power Saving Modes: L1 substates support Multi Queue support
Interface	PCI-E Gen3 x 4
Form Factor	M.2 2280
Height	3.73 mm
Width	22.00 ± 0.15 mm
Length	80.00 ± 0.15 mm
Weight	Up to 8 g
Bandwidth Performance	Sustained Sequential Read: Up to 2600 MB/s Sustained Sequential Write: Up to 1000 MB/s
Power	Power consumption: Active: Typical 6.1W; Idle: Typical 80mW L1.2: Typical 5mW
Mean Time Between Failure (MTBF)	1,500,000 hours
Environmental (all conditions, non-condensing)	Operating Temperature: 32° to 158° F (0° to 70° C) Relative Humidity: 5% to 95% Shock: 1,500 G/0.5 ms

Technical Specifications – Storage

Intel 256GB Three Layer Cell Pro 6000p Solid State Drive

Unformatted Capacity	256GB*	
Architecture	3D Tri-Level Cell (TLC) NAND	
Interface	PCIe NVMe 3.0 x4	
Form Factor	M.2 22 x 80mm	
Height	Up to 1.5mm	
Width	22mm	
Length	80mm	
Weight	Up to 40 g	
Bandwidth Performance	Sustained Sequential Read:	Up to 1570 MB/s
	Sustained Sequential Write:	Up to 540 MB/s
	Random Read:	Up to 80K IOPs
	Random Write:	Up to 70K IOPs
Power	Total power consumption:	200mW (active); 50mW (idle)
Mean Time Between Failure (MTBF)	1,600,000 Hours	
Useful Drive Life	144TB written, up to 80GB/day for 5 years	
Environmental (all conditions, non-condensing)	Operating Temperature:	32° to 158° F (0° to 70° C)
	Vibrating - Operating:	2.17 GRMS (5-700Hz) Max
	Vibrating - Non-Operating	3.13 GRMS (5-800Hz) Max

* For hard drives and solid state drives, GB = 1 billion bytes. TB = 1 trillion bytes. Actual formatted capacity is less. Up to 36 GB (for Windows 10) of system disk is reserved for the system recovery software.

512GB M2 SATA-3 Three Layer Cell Solid State Drive

Drive Weight	0.019 lb (8.5 g)- 0.02 lb (10 g)	
Capacity	512 GB	
Height	0.09 in (2.3 mm)- 0.14 in (3.58 mm)	
Width	0.87 in (22 mm)	
Interface	ATA-8, SATA 3.0	
Bandwidth Performance	Maximum Sequential Read:	500 ~ 540 MB/s
	Maximum Sequential Write:	440 ~ 515 MB/s
Logical Blocks	1,000,215,216	
Operating Temperature	32° to 158°F (0° to 70°C) [ambient temp]	
Features	ATA Security, DIPM; TRIM; DEVSLP	

512GB PCIe NVMe Three Layer Cell Solid State Drive

Unformatted Capacity	512 GB
Architecture	Solid State Drive with TLC NAND Flash and PCIe interface.
	Complies with NVMe Standard
	Power Saving Modes: L1 substates support
	Multi Queue support

Technical Specifications – Storage

Interface	PCI-E Gen3 x 4
Form Factor	M.2 2280
Height	3.73 mm
Width	22.00 ± 0.15 mm
Length	80.00 ± 0.15 mm
Weight	Up to 8 g
Bandwidth Performance	Sustained Sequential Read: Up to 2600 MB/s Sustained Sequential Write: Up to 1200 MB/s
Power	Power consumption: Active: Typical 6.1W; Idle: Typical 80mW L1.2: Typical 5mW
Mean Time Between Failure (MTBF)	1,500,000 hours
Environmental (all conditions, non-condensing)	Operating Temperature: 32° to 158° F (0° to 70° C) Relative Humidity: 5% to 95% Shock: 1,500 G/0.5 ms

512GB Turbo Drive G2 Multi-Layer Cell Solid State Drive

Drive Weight	0.02 lb (10g)
Capacity	512 GB
Height	0.09 in (2.3 mm) ~ 0.14 in (3.65 mm)
Width	0.87 in (22 mm)
Interface	PCIe NVMe Gen3X4
Bandwidth Performance	Maximum Sequential Read (128KB): 2,260 ~ 3,000 MB/s Maximum Sequential Write (128KB): 1,500 ~ 1,600 MB/s
Logical Blocks	1,000,215,216
Operating Temperature	32° to 158°F (0° to 70°C) [ambient temp]
Features	ATA Security (Option); TRIM; L1.2

Intel 512GB Three Layer Cell Pro 6000p Solid State Drive

Unformatted Capacity	512 GB
Architecture	3D Tri-Level Cell (TLC) NAND
Interface	PCIe NVMe 3.0 x4
Form Factor	M.2 2280
Height	Up to 1.5mm
Width	.22mm
Length	80mm
Weight (typical)	Up to 10 g
Bandwidth Performance	Sustained Sequential Read: Up to 1775 MB/s Sustained Sequential Write: Up to 560 MB/s Random Read: Up to 100k IOPS Random Write: Up to 90k IOPS
Power	Total power consumption: 200mW (active); 50mW (idle)

Technical Specifications – Storage

Mean Time Between Failure (MTBF)	1,600,000 Hours
Useful Drive Life	288 TBW Written, up to 160GB/day for 5 Years
Environmental (all conditions, non-condensing)	Operating Temperature: 32° to 158° F (0° to 70° C) Vibrating - Operating: 2.17 GRMS (5-700Hz) Max Vibrating – Non-Operating: 3.13 GRMS (5-800Hz) Max

1TB PCIe-3x4 NVMe Three Layer Cell Solid State Drive

Drive Weight	0.02 lb (10 g)
Capacity	1024 GB
Height	0.09 in (2.3 mm) ~ 0.14 in (3.65 mm)
Width	0.87 in (22 mm)
Interface	PCIe NVMe Gen3X4
Bandwidth Performance	Maximum Sequential Read: 2,500 ~ 3,000 MB/s Maximum Sequential Write: 1,400~ 1,700 MB/s
Logical Blocks	2,000,409,264
Operating Temperature	32° to 158°F (0° to 70°C) [ambient temp]
Features	ATA Security (Option); TRIM; L1.2

Technical Specifications – Networking and Communications

Realtek RTL8153

Connector	RJ-45
System Interface	USB 3.0
NIC Device Driver Name	PCIe GBE Ethernet Family Controller
Ethernet Features	<p>10 Mbit/s operation (10BASE-T; IEEE 802.3i; IEEE 802.3 clauses 13-14)</p> <p>100 Mbit/s operation (100BASE-TX; IEEE 802.3u; IEEE 802.3 clauses 21-30)</p> <p>1000 Mbit/s operation (1000BASE-T; IEEE 802.3ab; IEEE 8023 clauses 40)</p> <p>Auto-Negotiation (Automatic Speed Selection)</p> <p>Full Duplex Operation at all Speeds, Half Duplex operation at 10 and 100 Mbit/s</p> <p>IEEE 802.1p QoS (Quality of Service) Support</p> <p>IEEE 802.1q VLAN support</p> <p>IEEE 802.3x Flow Control (IEEE 802.3 clauses 31-32; configurable)</p> <p>IEEE 802.3az EEE (Energy Efficient Ethernet)</p> <p>Jumbo Frame 9K</p> <p>Auto MDI/MDIX Crossover cable detection</p>
Power Management	<p>ACPI compliant – multiple power modes</p> <p>Situation-sensitive features reduce power consumption</p> <p>Advanced link down power saving for reducing link down power consumption</p>
Performance Features	<p>TCP/IP/UDP Checksum Offload (configurable)</p> <p>Protocol Offload (ARP & NS)</p> <p>Large send offload and Giant send offload</p> <p>Receiving Side Scaling</p>
Manageability	<p>Wake-on-LAN from standby and hibernation (Magic Packet and Microsoft Wake-Up Frame); Wake-on-LAN from off (Magic Packet only)</p> <p>PXE 2.1 Remote Boot</p> <p>Statistics Gathering (SNMP MIB II, Ethernet-like MIB, Ethernet MIB (802.3x, clause 30))</p> <p>Comprehensive diagnostic and configuration software suite</p> <p>Virtual Cable Doctor for Ethernet cable status</p>

Intel® Dual Band Wireless-AC 8265 802.11a/b/g/n/ac (2x2) WiFi and Bluetooth® 4.2 Combo (non-vPro and vPro)

Wireless LAN Standards	<p>IEEE 802.11a</p> <p>IEEE 802.11b</p> <p>IEEE 802.11g</p> <p>IEEE 802.11n</p> <p>IEEE 802.11ac</p>
Interoperability	Wi-Fi certified
Frequency Band	<p>802.11b/g/n</p> <ul style="list-style-type: none"> 2.402 – 2.482 GHz <p>NOTE: The FCC has declared as of January 1, 2015 products that utilize passive scanning on channel 12/13 and are capable of transmitting must fully comply with requirements of 15.247 or otherwise disable those channels.</p> <p>802.11a/n</p> <ul style="list-style-type: none"> 4.9 – 4.95 GHz (Japan) 5.15 – 5.25 GHz

Technical Specifications – Networking and Communications

	<ul style="list-style-type: none"> • 5.25 – 5.35 GHz • 5.47 – 5.725 GHz • 5.825 – 5.850 GHz <p>NOTE: Indonesia no support this band)</p>
Data Rates	802.11a: 6, 9, 12, 18, 24, 36, 48, 54 Mbps 802.11b: 1, 2, 5.5, 11 Mbps 802.11g: 6, 9, 12, 18, 24, 36, 48, 54 Mbps 802.11n: MCS 0 ~ MCS 15 (20MHz and 40MHz) 802.11ac : MCS0 ~ MCS9, (1SS, and 2SS) (20MHz, 40MHz, and 80MHz)
Modulation	Direct Sequence Spread Spectrum CCK, BPSK, QPSK, 16-QAM, 64-QAM, 256-QAM
Security¹	<ul style="list-style-type: none"> • IEEE and WiFi compliant 64 / 128 bit WEP encryption for a/b/g mode only • AES-CCMP: 128 bit in hardware • 802.1x authentication • WPA, WPA2: 802.1x. WPA-PSK, WPA2-PSK, TKIP, and AES. • WPA2 certification • IEEE 802.11i • Cisco Certified Extensions, all versions through CCX4 and CCX Lite • WAPI
Network Architecture Models	Ad-hoc (Peer to Peer) Infrastructure (Access Point Required)
Roaming	IEEE 802.11 compliant roaming between band Access Points
Output Power²	<ul style="list-style-type: none"> • 802.11b : +16dBm minimum • 802.11g : +14dBm minimum • 802.11a : +14dBm minimum • 802.11n HT20(2.4GHz) : +14dBm minimum • 802.11n HT40(2.4GHz) : +12dBm minimum • 802.11n HT20(5GHz) : +14dBm minimum • 802.11n HT40(5GHz) : +12dBm minimum
Power Consumption	Transmit: 2.0 W (max) Receive: 1.6 W (max) Idle mode (PSP): 180 mW (WLAN Associated) Idle mode: 50 mW (WLAN unassociated) Connect Standby: 10 mW (WLAN+BT) Radio disabled: 5 mW
Power Management	ACPI and PCI Express compliant power management 802.11 compliant power saving mode
Receiver Sensitivity³	802.11b, 1Mbps : -94dBm maximum 802.11b, 11Mbps : -86dBm maximum 802.11g, 6Mbps : -88dBm maximum 802.11g, 54Mbps : -74dBm maximum 802.11a, 6Mbps : -88dBm maximum 802.11a, 54Mbps : -74dBm maximum 802.11n, MCS07 : -69dBm maximum 802.11n, MCS15 : -66dBm maximum 802.11ac, 1SS, MCS-0 : -86dBm maximum 802.11ac, 1SS, MCS-9 : -61 dBm maximum 802.11ac, 2SS, MCS-0 : -83dBm maximum

Technical Specifications – Networking and Communications

Antenna type	802.11ac, 2SS, MCS-9 : -58dBm maximum High efficiency antenna with spatial diversity, mounted in the display enclosure Two embedded dual band 2.4/5 GHz antennas are provided to the card to support WLAN MIMO communications and Bluetooth communications		
Form Factor	PCI-Express M.2 MiniCard		
Dimensions	Type 2230 : 2.3 x 22.0 x 30.0 mm Or Type 1630 : 2.3 x 16.0 x 30.0 mm		
Weight	Type 2230 : 2.8g Or Type 1630 : 2g		
Operating Voltage	3.3v +/- 9%		
Temperature	Operating	14° to 158° F (–10° to 70° C)	
	Non-operating	–40° to 176° F (–40° to 80° C)	
Humidity	Operating	10% to 90% (non-condensing)	
	Non-operating	5% to 95% (non-condensing)	
Altitude	Operating	0 to 10,000 ft (3,048 m)	
	Non-operating	0 to 50,000 ft (15,240 m)	
LED Activity	LED Amber – Radio OFF; LED White – Radio ON		
Notes	<p>1. Check latest software/driver release for updates on supported security features.</p> <p>2. Maximum output power may vary by country according to local regulations.</p> <p>3. Receiver sensitivity is measured at a packet error rate of 8% for 802.11b (CKK modulation) and a packet error rate of 10% for 802.11a/g (OFDM modulation).</p> <p>* Wireless access point and internet service required. Availability of public wireless access points limited.</p>		

HP Integrated Module with Bluetooth 4.0+EDR Wireless Technology (System Bluetooth Specifications)

Bluetooth Specification	4.0+EDR Compliant		
Frequency Band	2402 to 2480 MHz		
Number of Available Channels	79 (1 MHz) available channels		
Data Rates and Throughput	3 Mbps data rate; throughput up to 2.17 Mbps Synchronous Connection Oriented links up to 3, 64 kbps, voice channels Asynchronous Connection Less links 2178.1 kbps/177.1 kbps asymmetric or 1306.9 kbps symmetric		
Transmit Power	The Bluetooth component shall operate as a Class II Bluetooth device with a maximum transmit power of +4 dBm for BR and EDR.		
Receiver Sensitivity	Modulation	0.01% BER	0.001% BER
	GFSK	-80 dBm	-70 dBm

Technical Specifications – Networking and Communications

	π /4-DQPSK	-80 dBm	-70 dBm
	8DPSK	-80 dBm	-70 dBm
Power Consumption	Peak (Tx) 330 mW		
	Peak (Rx) 230 mW		
	Selective Suspend 17 mW		
Range	Up to 33 ft (10 m)		
Electrical Interface	USB 2.0 compliant		
Bluetooth Software Supported	Microsoft Windows Bluetooth Software		
Link Topology			
Electrical Interface	Point to Point, Multipoint Pico Nets up to 7 slaves		
Bluetooth Software Supported Security	Full support of Bluetooth Security Provisions		
Power Management	Microsoft Windows ACPI, and USB Bus Support		
Power Management Certifications	Self-configurable to optimize power conservation in all operating modes, including Standby, Hold, Park, and Sniff		
Security Certifications	All necessary regulatory approvals for supported countries, including:		
Bluetooth Profiles Supported	FCC (47 CFR) Part 15C, Section 15.247 & 15.249		
Power Management Certifications	ETS 300 328, ETS 300 826		
Certifications	Low Voltage Directive IEC950		
Bluetooth Profiles Supported	UL, CSA, and CE Mark		
	Serial Port Profile (SPP) ¹		
	Service Discovery Application Profile (SDAP)		
	Dial-Up Networking (DUN) ^{1,2}		
	Generic Object Exchange Profile (GOEP) ^{1,2}		
	Object Push Profile (OPP) ^{1,2}		
	File Transfer Profile (FTP)		
	Synchronization Profile (SYNC)		
	Hard Copy Cable Replacement (HCRP) ^{1,2}		
	Personal Area Networking Profile (PAN) ^{1,2}		
	Human Interface Device Profile (HID) ^{1,2}		
	FAX Profile (FAX)		
	Basic Imaging Profile (BIP) ²		
	Headset Profile (HSP)		
	Hands Free Profile (HFP)		
	Advanced Audio Distribution Profile (A2DP)		

Realtek 802.11b/g/n (1x1) WiFi and Bluetooth® 4.0 Combo

Wireless LAN Standards	IEEE 802.11b
	IEEE 802.11g
	IEEE 802.11n
Interoperability	Wi-Fi certified
Frequency Band	802.11b/g/n

Technical Specifications – Networking and Communications

- 2.402 – 2.482 GHz

NOTE: The FCC has declared as of September 1, 2014 products that utilize passive scanning on channel 12/13 and are capable of transmitting must fully comply with requirements of 15.247 or otherwise disable those channels.

Data Rates

- 802.11b: 1, 2, 5.5, 11 Mbps
- 802.11g: 6, 9, 12, 18, 24, 36, 48, 54 Mbps
- 802.11n: MCS 0 ~ MCS 07, (20MHz)

Modulation

Direct Sequence Spread Spectrum
BPSK, QPSK, CCK, 16-QAM, 64-QAM,

Security¹

- IEEE and WiFi compliant 64 / 128 bit WEP encryption for a/b/g mode only
- AES-CCMP: 128 bit in hardware
- 802.1x authentication
- WPA, WPA2: 802.1x. WPA-PSK, WPA2-PSK, TKIP, and AES.
- WPA2 certification
- IEEE 802.11i
- Cisco Certified Extensions, all versions through CCX4 and CCX Lite
- WAPI

Network Architecture Models

Ad-hoc (Peer to Peer)
Infrastructure (Access Point Required)

Roaming

IEEE 802.11 compliant roaming between access points

Output Power²

802.11b : +16dBm minimum
802.11g : +14dBm minimum
802.11n HT20(2.4GHz) : +13dBm minimum
802.11n HT40(2.4GHz) : +13dBm minimum
802.11n HT20(5GHz) : +12dBm minimum
802.11n HT40(5GHz) : +12dBm minimum

Power Consumption

Transmit: 2.0 W (max)
Receive: 1.6 W (max)
Idle mode (PSP): 180 mW (WLAN Associated)
Idle mode: 60 mW (WLAN unassociated)
Radio disabled: 30 mW

Power Management

ACPI and PCI Express compliant power management 802.11 compliant power saving mode

Receiver Sensitivity³

802.11b, 1Mbps : -94dBm maximum
802.11b, 11Mbps : -86dBm maximum
802.11g, 6Mbps : -88dBm maximum
802.11g, 54Mbps : -74dBm maximum
802.11n, MCS07 : -69dBm maximum
802.11n, MCS15 : -66dBm maximum

Antenna type

High efficiency antenna with spatial diversity, mounted in the display enclosure

Two embedded antennas for 2.4GHz are provided to the card to support WLAN and Bluetooth communications. (Support Dual antenna or Single antenna, depend on platform requirement)

Form Factor

PCI-Express M.2 MiniCard

Dimensions

Type 2230 : 2.3 x 22.0 x 30.0 mm
Or
Type 1630 : 2.3 x 16.0 x 30.0 mm

Weight

Type 2230 : 2.8g
Or
Type 1630 : 2g

Operating Voltage

3.3v +/- 9%

Technical Specifications – Networking and Communications

Temperature	Operating	14° to 158° F (–10° to 70° C)
	Non-operating	–40° to 176° F (–40° to 80° C)
Humidity	Operating	10% to 90% (non-condensing)
	Non-operating	5% to 95% (non-condensing)
Altitude	Operating	0 to 10,000 ft (3,048 m)
	Non-operating	0 to 50,000 ft (15,240 m)
LED Activity	LED Amber – Radio OFF; LED White – Radio ON	

1. Check latest software/driver release for updates on supported security features.
 2. Maximum output power may vary by country according to local regulations.
 3. Receiver sensitivity is measured at a packet error rate of 8% for 802.11b (CKK modulation) and a packet error rate of 10% for 802.11a/g (OFDM modulation).
-

Technical Specifications

POWER

Power Supply	120W for Basic Retail I/O connectivity Base, 180W or 200W for Advanced Retail I/O connectivity Base, 65W for Display Head Unit Only 120W, 88% efficient, active PFC (external), 180W or 200W, 89% efficient, active PFC (external), 65W, 89% efficient at 20V, active PFC (external)
Operating Voltage Range	90V~264VAC
Rated Voltage Range	100V~240AC
Rated Line Frequency	50~60HZ
Operating Line Frequency Range	47~63HZ
Rated Input Current	<2.2A/120W, <2.52A/180W, <2.9A/200W, 1.7A/65W
Power Supply Fan	N/A
ENERGY STAR® Compliant	ENERGY STAR® certified configurations available and EPEAT® registered configurations available
Power Cord Length	2 I/O Base Cable Options: (1) 45cm – when I/O Base is attached to Stand (2) 1.8m – when I/O Base is detached or display head only
Current Leakage (NFPA99)	Less than 300 microamps of leakage current at 120 Vac with the ground wire disconnected, as required for Non-patient Electrical Appliances and Equipment used in a patient care facility or that contact patients in normal use. Per section 10.3.5.1 of “National Fire Protection Association standard” NFPA99 2012 edition. Less than 100 microamps of leakage current at 120 Vac with the ground wire intact with normal polarity, as required for Non-patient Electrical Appliances and Equipment used in a patient care facility or that contact patients in normal use. Per section 10.3.5.1 of “National Fire Protection Association standard” NFPA99 2012 edition.

NOTE: This power supply meets ENERGY STAR® compliance in conjunction with a select range of processors and modules.

WEIGHTS & DIMENSIONS

NOTE: Weight and dimensions below do not include MSR, Biometric Reader, Webcam, or CFD.

Head unit (no MSR)	
Product Dimensions	336.2mm (L) X 216.4mm (D) X 17.6mm (H) , 13.2in x 8.5in x .7in
Dimension Note	Without stand

Rotate / tilt stand & fixed position stand/Column Printer	
Product Dimensions	96(L) x 96(D) x 220(H) mm / 260 (H) mm, 3.8in (L) x 3.8in (D) x 8.7in (H) / 10.2in (H)
Dimension Note	Fixed Position Stand & Rotate Tilt Stand w/ Integrated Column Printer

Retail I/O connectivity Base	
Product Dimensions	284 (L) x 162(D) x 29.2(H) mm, 11.2in (L) x 6.4in (D) x 1.1in (H)
Dimension Note	Connectivity Base Only

Technical Specifications

Display Head Unit with collar

Weight	1.4 kg / 3.1 lbs
Weight Note	Starting weight without stand. Exact weight depends on configuration.

Rotate / Tilt Stand

Weight	1.3 kg / 3.0 lbs
Weight Note	Weight of Rotate/Tilt Stand only

Fixed Position Stand

Weight	1.1 kg / 2.4 lbs
Weight Note	Weight of Fixed Position Stand only

Retail I/O Connectivity Base

Weight	.6 kg / 1.3 lbs
Weight Note	Weight of Connectivity Base only

Packaging Carton (Display Head & Hub Only)

Packaging Dimensions	552mm (L) X 165mm (D) X 318mm (H) , 21.7in x 6.5in x 12.5in
-----------------------------	---

Packaging Carton (Display Head, Stand & Hub)

Packaging Dimensions	495mm (L) X 295mm (D) X 453mm (H) , 19.5in x 11.6in x 17.8in
-----------------------------	--

Bundled Packaging

Weight	11.8 kg / 26 lbs
Weight Note	Weight of Bundled Packaging only

Display Head Only Packaging

Weight	4.3 kg / 9.3 lbs
Weight Note	Weight of Display Head Packaging only

Standard Packaging

Weight	7.2 kg / 15.9 lbs
Weight Note	Weight of Standard Packaging only

Technical Specifications

MISCELLANEOUS FEATURES

Management Features

- Advanced Configuration and Power Management Interface (ACPI). Allows the system to wake from a low power mode.
- Controls system power consumption, making it possible to place individual cards and peripherals in a low-power or powered-off state without affecting other elements of the system.
- Intel® Wired for Management support; industry wide initiative to make Intel® architecture based PCs, servers and mobile computers more inherently manageable out-of-the-box and over the network
- Dual State Power Button; acts as both an on/off button and a suspend-to-sleep button

HP Point of Sale Diagnostics UEFI:

- This utility enables hardware level testing outside the operating system on many components. The diagnostics can be invoked by pressing F2 at POST, and is available as a download from HP Support

Serviceability Features:

- System/Emergency ROM
- Flash ROM
- Flash Recovery with Video Configuration Record Software
- Over-Temp Warning on Screen (Requires IM Agents)
- Clear Password Jumper
- Clear CMOS Button
- Color coordinated cables and connectors
- Front power switch
- System memory can be upgraded without removing the system board or any internal components

Interpreting System Validation Diagnostic Front Panel LEDs and Audible Codes

During the system validation phase that occurs at system startup, the BIOS validates the functionality of the following subsystems and conditions:

- AC adapter
- System board power
- Processor failure
- BIOS corruption
- Memory failure
- Graphics failure
- System board failure
- BIOS authentication failure

If an error is detected, specific patterns of long and short blinks, accompanied by long and short beeps (where applicable) are used to identify the error. These patterns will make up a two part code:

- Major – the category of the error
- Minor – the specific error within the category

 **NOTE:** Single beep/blink codes are not used.

Number of long beeps/blinks	Error category
1	Not used
2	BIOS

Technical Specifications

3	Hardware
4	Thermal
5	System board

Patterns of blink/beep codes are determined by using the following parameters:

- 1 second pause occurs after the last major blink.
- 2 second pause occurs after the last minor blink.
- Beep error code sequences occur for the first 5 iterations of the pattern and then stop.
- Blink error code sequences continue until the computer is unplugged or the power button is pressed.



NOTE: Not all diagnostic lights and audible codes are available on all models.

The red LED blinks to represent the major error category (long blinks). The white LED blinks to represent the minor error category (short blinks). For example, '3.5' indicates 3 long red blinks and 5 short white blinks to communicate the processor is not detected.

Category	Major/minor code	Description
BIOS	2.2	The main area (DXE) of BIOS has become corrupted and there is no recovery binary image available.
	2.3	The embedded controller policy requires the user to enter a key sequence.
	2.4	The embedded controller is checking or recovering the boot block.
Hardware	3.2	The embedded controller has timed out waiting for BIOS to return from memory initialization.
	3.3	The embedded controller has timed out waiting for BIOS to return from graphics initialization.
	3.4	The system board displays a power failure (crowbar).*
	3.5	The processor is not detected.*
Thermal	3.6	The processor does not support an enabled feature.
	4.2	A processor over temperature condition has been detected.*
	4.3	An ambient temperature over temperature condition has been detected.
System board	4.4	An MXM over temperature condition has been detected.
	5.2	The embedded controller cannot find valid firmware.
	5.3	The embedded controller has timed out waiting for the BIOS.
	5.4	The embedded controller has timed out waiting for BIOS to return from system board initialization.
	5.5	The embedded controller rebooted the system after a possible lockup condition had been detected through the use of a System Health Timer, Automated System Recovery Timer, or other mechanism.

* Indicates hardware triggered event; all other events are controlled by the BIOS.

Additional Features Description

Technical Specifications

Drive Lock	Implementation of the industry standard ATA Security feature set. When enabled, it prevents software access to user data on the drive until one or two user-defined passwords are provided. DPS Access through F10 Setup during Boot A diagnostic hard drive self-test. It scans critical physical components and every sector of the hard drive for physical faults and then reports any faults to the user
Drive Protection System	Running independently of the operating system, it can be accessed through a Windows-based diagnostics utility or through the computer's setup procedure. It produces an evaluation on whether the hard drive is the source of the problem and needs to be replaced The system expands on the Self-Monitoring, Analysis, and Reporting Technology (SMART), a continuously running systems diagnostic that alerts the user to certain types of failures
SMART Technology (Self-Monitoring, Analysis and Reporting Technology)	Allows hard drives to monitor their own health and to raise flags if imminent failures were predicted
SMART I - Drive Failure Prediction	Predicts failures before they occur. Tracks fault prediction and failure indication parameters such as re-allocated sector count, spin retry count, calibration retry count
SMART II - Off-Line Data Collection	By avoiding actual hard drive failures, SMART hard drives act as "insurance" against unplanned user downtime and potential data loss from hard drive failure
SMART III - Off-Line Read Scanning	IOEDC: I/O Error Detection Circuitry
Defect Reallocation	Detects errors in Read/Write buffers on HDD cache RAM
SMART IV - End-to-End CRC for hard drives	Interface in F10 setup provides confirmation of SMART IV support.

TEMPERATURE, HUMIDITY, ALTITUDE

Temperature	Operating	50° to 104° F (10 to 40° C)
	Non-operating	-22° to 149° F (-30° to 65° C)
Humidity	Operating	5%-95% relative humidity at max inlet temperature
	Non Operating	5%-95% relative humidity at max inlet temperature
Shock	Operating	40g, six surfaces
	Non Operating	30g, six surfaces
Vibration	Operating	2-g peak acceleration
	Non Operating	3-g peak acceleration
Altitude (unpressurized)	Operating	0 to 10,000 ft (3,048 m)
	Non-operating	0 to 30,000 ft (9,144 m)

Technical Specifications

ENVIRONMENTAL & INDUSTRY

Environmental Data

Eco-Label Certifications & declarations

This product has received or is in the process of being certified to the following approvals and may be labeled with one or more of these marks:

- IT ECO declaration
- US ENERGY STAR® certified configurations available
- EPEAT® Silver registered configurations available in the United States. See <http://www.epeat.net> for registration status in your country.

System Configuration

The configuration used for the Energy Consumption and Declared Noise Emissions data for the Engage One model is based on a typically configured system featuring a hard disk drive, a high efficiency power supply, and a Microsoft Windows® operating system.

HP Engage One AiO System Model 141

Energy Consumption (in accordance with US ENERGY STAR® test method)

	115VAC, 60Hz	230VAC, 50Hz	100VAC, 60Hz
Normal Operation (Short idle)	12.58W	13.07W	12.65 W
Normal Operation (Long idle)	10.71 W	10.96W	10.79 W
Sleep	3.28 W	3.31W	3.26W
Off	1.15W	1.18 W	1.15 W

Heat Dissipation*

	115VAC, 60Hz	230VAC, 50Hz	100VAC, 60Hz
Normal Operation (Short idle)	42.89 BTU/hr	44.59 BTU/hr	43.02 BTU/hr
Normal Operation (Long idle)	36.54 BTU/hr	37.39 BTU/hr	36.74 BTU/hr
Sleep	11.15 BTU/hr	11.29 BTU/hr	11.12 BTU/hr
Off	3.92 BTU/hr	3.99 BTU/hr	3.92 BTU/hr

* Heat dissipation is calculated based on the measured watts, assuming the service level is attained for one hour

Declared Noise Emissions (in accordance with ISO 7779 and ISO 9296)

	Sound Power (L _{WAd} , bels)	Sound Pressure (L _{pAm} , decibels)
Typically Configured – Idle	2.7	17
Fixed Disk – Random writes	2.7	17

NOTE: Energy efficiency data listed is for an ENERGY STAR® compliant product if offered within the model family . HP computers marked with the ENERGY STAR® Logo are compliant with the applicable U.S. Environmental Protection Agency (EPA) ENERGY STAR® specifications for computers. If a model family does not offer ENERGY STAR® compliant configurations, then energy efficiency data listed is for a typically configured PC featuring a hard disk drive, a high efficiency power supply, and a Microsoft Windows® operating system.

HP Engage One AiO System Model 143/145

Energy Consumption (in accordance with US ENERGY STAR® test method)

	115VAC, 60Hz	230VAC, 50Hz	100VAC, 60Hz
Normal Operation (Short idle)	12.58W	13.07W	12.65 W
Normal Operation (Long idle)	10.71 W	10.96W	10.79 W
Sleep	3.28 W	3.31W	3.26W
Off	1.15W	1.18 W	1.15 W

Technical Specifications

Heat Dissipation*	115VAC, 60Hz	230VAC, 50Hz	100VAC, 60Hz
Normal Operation (Short idle)	42.89 BTU/hr	44.59 BTU/hr	43.02 BTU/hr
Normal Operation (Long idle)	36.54 BTU/hr	37.39 BTU/hr	36.74 BTU/hr
Sleep	11.15 BTU/hr	11.29 BTU/hr	11.12 BTU/hr
Off	3.92 BTU/hr	3.99 BTU/hr	3.92 BTU/hr

* Heat dissipation is calculated based on the measured watts, assuming the service level is attained for one hour

Declared Noise Emissions (in accordance with ISO 7779 and ISO 9296)	Sound Power (L_{WAd}, bels)	Sound Pressure (L_{pAm}, decibels)
Typically Configured – Idle	2.7	17
Fixed Disk – Random writes	2.7	17

Technical Specifications

Longevity and Upgrading

This product can be upgraded, possibly extending its useful life by several years. Upgradeable features and/or components contained in the product may include:

- 2 memory slots
- M.2 2230 slot for WLAN
- (1) M.2 2280 slot for SSD
- (4) USB Ports (2 – USB 2.0; 2 – USB 3.0) Plug in ports for 2 bases

Spare parts are available throughout the warranty period and or for up to “5” years after the end of production.

Batteries

This battery(s) in this product comply with EU Directive 2006/66/EC

Batteries used in the product do not contain:

- Mercury greater than 1ppm by weight
- Cadmium greater than 20ppm by weight

Battery size: CR2032 (coin cell)

Battery type: Lithium

Additional Information

- This product is in compliance with the Restrictions of Hazardous Substances (RoHS) directive - 2011/65/EC.
- This HP product is designed to comply with the Waste Electrical and Electronic Equipment (WEEE) Directive – 2002/96/EC.
- This product is in compliance with California Proposition 65 (State of California; Safe Drinking Water and Toxic Enforcement Act of 1986).
- This product is in compliance with the IEEE 1680.1 (EPEAT) standard at the <Silver> level, see www.epeat.net
- Plastics parts weighing over 25 grams used in the product are marked per ISO11469 and ISO1043.
- This product contains 45.16% post-consumer recycled plastic (by wt.)
- This product is 96% recycle-able when properly disposed of at end of life.
- EMC Compliant: IEC 60601-1-2

Packaging Materials

External:	PAPER/Corrugated	1380 g
Internal:	PLASTIC/Polyethylene Expanded - EPE	534 g
	PLASTIC/Polyethylene low density – LDPE	22 g

The EPE foam packaging material is made from 0% recycled content.

The corrugated paper packaging materials contains at least 25% recycled content.

Material Usage

This product does not contain any of the following substances in excess of regulatory limits (refer to the HP General Specification for the Environment at

<http://www.hp.com/hpinfo/globalcitizenship/environment/pdf/gse.pdf>):

- Asbestos
- Certain Azo Colorants
- Certain Brominated Flame Retardants – may not be used as flame retardants in plastics
- Cadmium
- Chlorinated Hydrocarbons
- Chlorinated Paraffins
- Formaldehyde
- Halogenated Diphenyl Methanes
- Lead carbonates and sulfates
- Lead and Lead compounds

Technical Specifications

- Mercuric Oxide Batteries
- Nickel – finishes must not be used on the external surface designed to be frequently handled or carried by the user.
- Ozone Depleting Substances
- Polybrominated Biphenyls (PBBs)
- Polybrominated Biphenyl Ethers (PBBEs)
- Polybrominated Biphenyl Oxides (PBBOs)
- Polychlorinated Biphenyl (PCB)
- Polychlorinated Terphenyls (PCT)
- Polyvinyl Chloride (PVC) – except for wires and cables, and certain retail packaging has been voluntarily removed from most applications.
- Radioactive Substances
- Tributyl Tin (TBT), Triphenyl Tin (TPT), Tributyl Tin Oxide (TBTO)

Packaging Usage

HP follows these guidelines to decrease the environmental impact of product packaging:

- Eliminate the use of heavy metals such as lead, chromium, mercury and cadmium in packaging materials.
- Eliminate the use of ozone-depleting substances (ODS) in packaging materials.
- Design packaging materials for ease of disassembly.
- Maximize the use of post-consumer recycled content materials in packaging materials.
- Use readily recyclable packaging materials such as paper and corrugated materials.
- Reduce size and weight of packages to improve transportation fuel efficiency.
- Plastic packaging materials are marked according to ISO 11469 and DIN 6120 standards.

End-of-life Management and Recycling

HP Inc. offers end-of-life HP product return and recycling programs in many geographic areas. To recycle your product, please go to: <http://www.hp.com/go/reuse-recycle> or contact your nearest HP sales office. Products returned to HP will be recycled, recovered or disposed of in a responsible manner.

The EU WEEE directive (2002/95/EC) requires manufacturers to provide treatment information for each product type for use by treatment facilities. This information (product disassembly instructions) is posted on the HP Inc. web site at: <http://www.hp.com/go/recyclers>. These instructions may be used by recyclers and other WEEE treatment facilities as well as HP OEM customers who integrate and re-sell HP equipment.

HP Inc. Corporate Environmental Information

For more information about HP's commitment to the environment

Global Citizenship Report

<http://www.hp.com/hpinfo/globalcitizenship/gcreport/index.html>

Eco-label certifications

<http://www8.hp.com/us/en/hp-information/environment/ecolabels.html>

ISO 14001 certificates:

[PC Product Design ISO 14001 certificate](#)

and

[HP Operations ISO 14001 certificate](#)

SERVICE AND SUPPORT

Technical Specifications

Ninety-day (90-90-90), one-year (1-1-1), and three-year (3-3-3) limited warranty delivers (ninety days/one year/three years) of on-site, next business day² service for parts and labor and complimentary limited technical support.³ Three-year onsite and labor are not available in all countries. Service offers terms up to 5 years by choosing an optional HP Care Pack.¹ To choose the right level of service for your HP product, visit HP Care Pack Central: <http://www.hp.com/go/cpc>

NOTES:

1. Terms and conditions may vary by country. Certain restrictions and exclusions apply. Other warranty variations may be offered in your region.
 2. On-site service may be provided pursuant to a service contract between HP and an authorized HP third-party provider, and is not available in certain countries. Global service response times are based on commercially reasonable best effort and may vary by country.
 3. Technical support applies only to HP-configured Compaq and third-party HP-qualified hardware and software. 24 x 7 support may not be available in some countries.
-

HP Engage One Peripherals

HP USB-C Mini Dock



Models

HP USB-C Mini Dock	1PM64AA
HP USB C Mini Dock + 90W Adapter + PC EU	3PR57AA#ABB
HP USB C Mini Dock + 90W Adapter + PC HE	3PR57AA#ABT
HP USB C Mini Dock + 90W Adapter + PC UK	3PR57AA#ABU
HP USB C Mini Dock + 90W Adapter + PC DE	3PR57AA#ABY
HP USB C Mini Dock + 90W Adapter + PC SA	3PR57AA#ACQ
HP USB C Mini Dock + 90W Adapter + PC US	3PR57AA#ABA
90W AC Adapter	2LN85AA

General	Ports	1 USB-C™ charging/data port 2 USB ports (1 USB 3.0, 1 USB 2.0) 1 Ethernet port (10/100/1000) 1 VGA port 1 HDMI
	Weight	.29 lb (0.132 kg)
	Video resolution	Only single display supported HDMI: 4096 x 2160 @ 30Hz VGA: 1920 x 1080
Stand-alone power requirements	Normal Operating Voltage	5V
	Average Operating Power	12W
	Max Operating Power	15W
Temperature	Operating	32~104 °F (0~40 °C)
	Non-operating	-4~140 °F (-20~+60 °C)
Relative humidity	Operating	5%~90% RH, non-condensing
	Non-operating	5%~95% RH, non-condensing
Altitude	Operating	10000 ft. (3048 m) @2 hours
	Non-operating	30000 ft. (9144 m) @ 2 hours
Shock	Operating	40G, 2ms, half-sine

HP Engage One Peripherals

Random vibration	Non-operating	240G, 2ms, half-sine
	Operating	~2.09Grms, 5-500 Hz, Non-Operating
	Non-operating	~2.09Grms, 5-500 Hz, Non-Operating
Network manageability	PXE Boot;	
	Wake On Lan (WoL)	
	NOTE: your computer might support WoL Through from the Off, Sleep or Hibernation States, or only when the computer is On or in Sleep.	
	MAC Address Pass Through	
	NOTE: your computer might support MAC Address Pass Through from the On, Off, Sleep or Hibernation States, or only when the computer is On or in Sleep, Supported for UEFI PXE Boot);	
	WLAN – LAN switching	
	NOTE: supported only on select computers running Windows 10 operating system.	
Power Delivery (PD)	USB-C PD 3.0 supporting 90W USB-C AC Adapters (not included)	
	- 90W USB-C AC Adapter supports 20V/3A	
Option Kit Contents	HP USB-C Mini Dock, Documentation	

HP Engage One Peripherals

HP Engage One 2D Barcode Scanner



Model

HP Engage One 2D Barcode Scanner (Black)
 HP Engage One 2D Barcode Scanner (White)

1RL97AA
 3GS20AA

General

Scanner Type	2D Imager
Light source	White LED
Read Rate	30 frames/seconds
Nominal working distance	Depth of Field Minimum distance determined by symbol length and scan angle. Printing resolution, contrast, and ambient light dependent.

Typical Performance *

Narrow Width	Depth of Field
10 mil Code 39	27.94-330.2 mm (1.1-13.0")
10 mil Code 128	27.94-330.2 mm (1.1-13.0")
100% UPC-A	45.72-419.1 mm (1.8-16.5")
10 mil Aztec	53.34-203.2 mm (2.1-8.0")
6.7 mil PDF 417	45.72-182.88 mm (1.8 - 7.2")
10 mil DM**	53.34-203.2 mm (2.1 - 8.0")

HP Engage One Peripherals

* Performance may be impacted by bar code quality and environmental conditions

** Data Matrix (DM)

Symbol Contrast	35% minimum reflectance difference
Roll (tilt)	± 360°
Pitch	± 60°
Skew	± 70°
1D decode symbologies	UPC/EAN (A) UPC/EAN (E) UPC/EAN/ (13) UPC/EAN (8) Code 39 (Regular) Code 128 EAN 128 Code 93 GS1 Databar Omnidirectional GS1 DataBar Stacked GS1 DataBar Truncated GS1 Databar Expanded UPC/EAN/JAN (ISBN) UPC/EAN/JAN (Bookland) UPC/EAN/JAN (ISSN) ISSN - 2 EAN 13/P2 (with 2 digits Add-On) EAN 13/P5 (with 5 digits Add-On) Code 39 (including full ASCII) Code39 CIP (French Pharmaceutical) Code 39 (trioptic) LOGMARS (Code 39 w/ standard check digit enabled) Code 32 (Italian Pharmacode 39) Interleaved 2 of 5 Standard 2of 5 Industrial 2 of 5 Code 11 (with two check digits) Code 11 (with one check digit) Codabar MSI PZN - code 39 GS1 DataBar Limited Codablock F
2D decode symbologies	Datamatrix QR Codes (QR, Micro QR and Multiple QR Codes) PDF-417 Aztec Maxicode Micro PDF417 Datamatrix (2D inversed) Chinese Sensible Code GS1 DataBar Stacked Omni-directional GS1 DataBar Expanded Stacked Postal Codes Australian Japanese

HP Engage One Peripherals

Planet
Postnet
Royal Mail

Mechanical

Dimensions (L x W x H)	125 x 44 x 76.8 mm (4.92 x 1.73 x 3.02 in)
Weight	130 g (4.59 oz)
Cable length	2m
Color	Ebony Black or Ceramic White

Interface/Connection

Cable	USB
--------------	-----

Temperature

Operating	32°F to 122°F (0°C to 50°C)
While Charging	32°F to 104°F (0°C to 40°C)
Storage/transport	-40 to 158 °F (-40 to 70 °C)
Humidity (non-condensing)	0 to 95% relative humidity

Power

Idle Current	Standby/Idle (Typical):< 70mA
Input Voltage	5V, 500mA

Drivers

Windows USB COM, OPOS, and JPOS

Operating System

Compatible with:	Windows Windows 10 IoT Enterprise for Retail (64-bit) Windows 10 Pro (64-bit)
	Linux Red Hat/Cento 6 and 7 (32-bit and 64-bit) Suse Linux® Enterprise POS 11 SP3 (32-bit and 64-bit) Ubuntu 14.04 LTS (32-bit and 64-bit)

Agency Certifications

C-Tick, KCC, BSMI, VCCI, CSA, CE, FCC

Option Kit Contents

HP Engage One 2D Barcode Scanner with attached 6.5 ft (2M) USB cable, Scanner Stand.

HP Engage One Peripherals

HP Engage One Fingerprint Reader



Models

HP Engage One Fingerprint Reader (Black)	1RL98AA
HP Engage One Fingerprint Reader (White)	3GS21AA

Model	HP Engage One Fingerprint Reader	1RL98AA
General	Scan Data	8-bit grayscale (256 levels of gray)
	Pixel resolution	508 DPI
	Scan capture area	18mm x 1280mm
Mechanical	Standalone Dimensions(LxWxH)	162 x 30 x 20.7 (mm) (6.38 x 1.18 x .81 in)
	Attached Dimensions (LxWxH)	162x30 x29.2 (mm) (6.38 x 1.18 x 1.15 in)
	Standalone Weight	79g (2.79 oz)
	Attached Weight	116g (4.09 oz)
Interface/Connection	Color	Ebony Black or Ceramic White
	Interface	USB 2.0

HP Engage One Peripherals

Power	Supply Voltage	5.0V ±5% supplied by USB
	Supply Current Imaging Mode	80 mA @ 3.3V
	Supply Current Sleep Mode	1350 uA @ 3.3V
Environmental	Temperature	- 20 C to + 70 C
	Humidity	5% to 93% RH w/o condensation
Drivers		Windows
Operating Systems	Compatibility	Windows Windows 10 IoT Enterprise for Retail 64-bit*,*** Windows 10 Professional 64-bit*,*** Windows 8.1 Professional 64-bit** Windows Industry 8.1 Pro Retail 64-bit** Windows 7 Professional 64-bit** Windows 7 Professional 32-bit** Windows Embedded POSReady 7 64-bit** Windows Embedded POSReady 7 32-bit** Linux Ubuntu 12.04 Ubuntu 13.04 Ubuntu 14.04
Reliability	Surface Coating	Scratch Resistant Withstands more than 4 million rubs
	Readability	More than 100,000 read/write cycle More than 20 yrs data retention Works well with dry, moist, or rough fingerprints
	Security	Counterfeit Finger Rejection Latent Print Rejection Encryption Fingerprint Data

* Not all features are available in all editions or versions of Windows. Systems may require upgraded and/or separately purchased hardware, drivers, software or BIOS update to take full advantage of Windows functionality. Windows 10 is automatically updated, which is always enabled. ISP fees may apply and additional requirements may apply over time for updates. See <http://www.microsoft.com>

** Not all features are available in all editions of Windows. This system may require upgraded and/or separately purchased hardware to take full advantage of Windows functionality. See <http://www.microsoft.com>.

*** Full support on all x86-based Windows, NO current support drivers for ARM processor platforms.

HP Engage One Peripherals

HP Engage One Top Mount 2x20 CFD

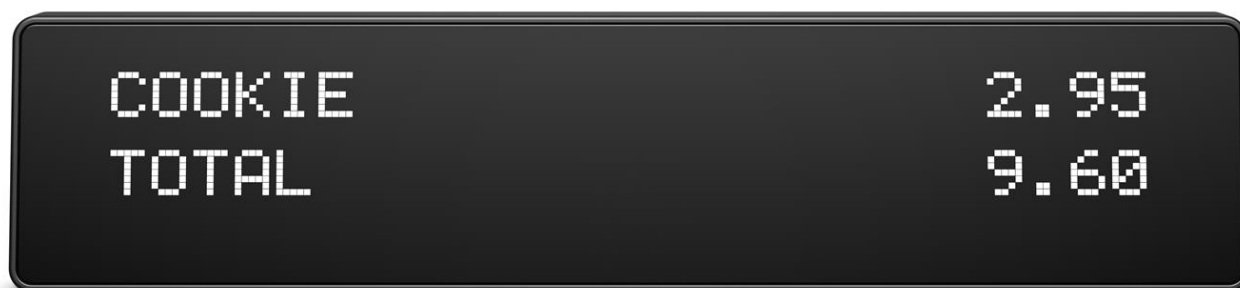

Models

HP Engage One Top Mount 2x20 CFD (Black)

1RL95AA

HP Engage One Top Mount 2x20 CFD (White)

3GS18AA

General

Display Type	TFT LCD
Resolution	480(W) x 3(GB) x 64(H) Pixel Dots
Average Brightness	600 cd/m ²
Display Mode	Alphanumeric: 20 digits x 2 lines
Character Dot Matrix	24x32 dots for 20 x 2
Dot Size (X *Y)	0.279 (W) x 0.281 (H) mm
Character Type	Alphanumeric and Compound (2-Bytes) Words
Character Size	9.0 (H) mm x 6.7 (W) mm
User Define Character	96 characters
Language	Compound (2-Bytes Words): Arabic

HP Engage One Peripherals

Japanese
 Korean
 Persian
 Simplified Chinese
 Traditional Chinese

Alphanumeric:

Bosnian
 Croatian
 Czech
 Danish
 Dutch
 English (US)
 Estonian
 Faroese
 Finnish
 Flemish
 French
 French Canadian
 German
 Greek
 Hebrew
 Hungarian
 Icelandic
 Indonesian
 International English
 Irish
 Italian
 Katakana
 Latvian
 Lithuanian
 Norwegian
 Polish
 Portuguese
 Romanian
 Russian
 Slovak
 Slovene
 Spanish
 Swedish
 Turkish

Viewing Direction 12 O'clock : Customer application
 6 O'clock: Gray scale inversion

Viewing Area 135.28 (W) * 19.0 (L)

Viewing Angle $\theta_L \phi = 180^\circ$ (9 o'clock) 70 degree
 $\theta_R \phi = 0^\circ$ (3 o'clock) 70 degree
 $\theta_T \phi = 90^\circ$ (12 o'clock) 50 degree
 $\theta_B \phi = 270^\circ$ (6 o'clock) 70 degree

Command Modes ADM788, AEDEX, CD5520, DSP880, EMAX, Epson, LD540, Logic Control, UTC/P / UTC/S

Mechanical

Product Dimensions 157.47 (W) x 34.47 (H) x 12.9 (D) mm (6.2 x 1.36 x .51 in) (metal bracket for inserting to platform excluded)

Panel Dimensions 148.9 (W) x 29.1 (L) x 3.35 (H) (5.86 x 1.15 x .132 in)

Net Weight Approx. 110 grams (3.88 oz)

HP Engage One Peripherals

	Color	Ebony Black or Ceramic White
Interface/Connection	Interface	USB
	Baud Rate	Direct connection 9600
Power	Voltage (typical)	5VDC +/-10%
	Current consumption (typical)	400mA
Reliability	MTBF	30,000 hours
Operating Systems (Compatible with)	Windows	Windows 10 IoT Enterprise for Retail (64-bit)* Windows 10 Pro (64-bit)*
	Linux	Red Hat/CentOS 6 and 7 (32-bit and 64-bit) Suse Linux® Enterprise POS 11 SP3 (32-bit and 64-bit) Ubuntu 14.04 LTS (32-bit and 64-bit)
Drivers		Windows USB COM, OPOS, JPOS
Certifications		FCC, CE, VCCI, RCM, KCC, ICE, CSA, EAC
Kit Contents		HP Engage One Top Mount 2x20 CFD, 2 screws

* Not all features are available in all editions or versions of Windows. Systems may require upgraded and/or separately purchased hardware, drivers, software or BIOS update to take full advantage of Windows functionality. Windows 10 is automatically updated, which is always enabled. ISP fees may apply and additional requirements may apply over time for updates. See <http://www.microsoft.com>.

**Not all features are available in all editions or versions of Windows. Systems may require upgraded and/or separately purchased hardware, drivers, software or BIOS update to take full advantage of Windows functionality. See <http://www.microsoft.com>.

HP Engage One Peripherals

HP Engage One Column Printer



Models

HP Engage One Column Printer

Configurable option only in black or white. Not available as after-market option.

General

Supported Character Sets Resident Code Pages:

- 437 (US)
- 720 (Arabic)
- 737 (Greek)
- 775 (Lithuanian)
- 850 (Multilingual)
- 852 (Slavic)
- 857 (Turkish)
- 858 (with Eurosymbol)
- 860 (Portuguese)
- 862 (Hebrew)
- 863 (French Canadian)
- 864 (Arabic)
- 865 (Nordic)
- 866 (Cyrillic)
- 874 (Thai)
- 932 (Kanji)
- 936 (Simplified Chinese)
- 949 (Korean - Hangul)
- 950 (Traditional Chinese)
- KZ_1048 (Kazakh)
- 1250 (Latin)

HP Engage One Peripherals

1251 (Cyrillic)
 1252 (Windows Latin 1)
 1254 (Turkish)
 1255 (Hebrew)
 1256 (Arabic)
 1257 (Baltic)
 Katakana
 28591 (ISO8859-1, Latin 1)
 28592 (ISO8859-2, Latin 2)
 28594 (ISO8859-4, Latin 4)
 28596 (ISO8859-6, Latin/Arabic)
 28599 (ISO8859-5, Latin 5/Turkish)
 28605 (ISO8859-15, Latin 9)
 Unicode UTF-8 encoding for listed code pages

	Bar Codes	1D: UPC-A, UPC-E, EAN8, EAN13, Code 39, Code 93, Interleaved 2 of 5 Codabar, Code 128, Code 128, EAN 128, GS1 Databar 2D: Datamatrix, QR code, PDF 417
	Print Method	Direct Thermal
	Printing Speed	114 mm/sec (33.75 LPS)
	Paper Sensor	Low: No Out: Yes
	Resolution	203 DPI
	Flash Memory	8 MB
	RAM	8 MB
	Knife	Full and Partial cuts supported
	Receipt-Columns	44/56
	Paper Type	Direct Thermal Monochrome POS Grade(s)
	Paper Roll Size (W x D)	3.1 in. X 2 in. (80 mm X 51 mm)
	Paper Thickness Range	2.3 – 3.2 mil
	Cash Drawers	1 connector can drive 2 cash drawers with separately purchased splitter cable (default configuration is connection to 1 cash drawer)
Mechanical	Dimensions (DxH)	3.78 in. (D) x 5.5 in. (H) (96 mm x 140 mm)
	Color	Ebony black or Ceramic white
Interface/Connection	Interface	Standard USB 2.0 cable Type A to Type B mini 24V Cash Drawers support with RJ 12 interface
Power	External Power Supply	48 w
	Operating Voltage	24 V
	Full Load Current	2 A w/ active power management system
	Idle Current	25mA

HP Engage One Peripherals

Temperature Range	Idle Power	0.6 W
	Operating	41°F to 95°F (5°C to 35°C) at 5% to 90% humidity 95°F to 122°F (35°C to 50°C) at 5% to 40% humidity
	Non-operating	Transit range: -40°F to 140°F (-40°C to 60°C) 5% to 95% humidity Storage range: 14°F to 122°F (35°C to 50°C) at 5% to 90% humidity
Drivers	Windows, OPOS, JPOS	
Operating Systems	Windows	
	<ul style="list-style-type: none"> • Windows 10 IoT Enterprise for Retail (64-bit) • Windows 10 Pro (64-bit) 	
	Linux	
	<ul style="list-style-type: none"> • Red Hat/CentOS 6 and 7 (32-bit and 64 bit) • Suse Linux® Enterprise POS 11 and 12 (32-bit and 64-bit) • Ubuntu 14.04 LTS (32-bit and 64-bit) 	
Reliability	MCBF Print Mechanism: 29-million lines MCBF Knife Cuts: 1-million Print Head Life: 100 km	
Agency Certifications	Flammability: UL 94V-0	
	Safety: UL 60950-1 2nd edition 2014-10-14; UL 62382-1 CAN/CSA C22.2 No. 60950-1-07, 2nd Edition, 2014-10 EN 60950-1:2006 + A1:2010+ A2:2013 CB Report: IEC 60950-1:2005 + A1:2009 + A2:2013 IEC/EN 62382-1 2ND Edition GB4943.1-2011-China IS 13252-1 (2010)/A1:2013/A2:2015	
	Radiated Emissions: FCC 47CFR, Part 15, Class B ICES-003: 2012, Issue 6, Class B EN 55032:2015 Class B CISPR32 VCCI: V-3 Class B ITE VCCI-CISPR32 AS/NZS 3548	
	Immunity: EN55024: 2010 EN61000-4-2 Level 4 (8kV direct, 15kV air discharge) EN61000-4-3: Level 3 (10V/m) EN61000-4-6 Level 3 (10V rms) EN61000-4-4: Level 3 (2kV mains, 1kV data lines)	

HP Engage One Peripherals

RoHS, WEEE

Option kit contents

Starter paper roll

NOTE: This printer does not comply with fiscalization requirements that may be required in certain countries.

HP Engage One Peripherals

HP Engage One MSR



Models

HP Engage One MSR

Configurable option only in black or white. Not available as after-market option.

General

Magnetic stripe formats

ISO 7811, AAMVA

Type

Singe-head, bi-directional, 3-Track, encryption capable

Card thickness

0.015 to 0.045 in (0.38 to 1.14 mm)

Indicators

Bi-colored LED, beeper (requires system audio driver)

Mechanical

Slot width

0.045 in (1.14 mm)

Color

Ebony Black or Ceramic White

HP Engage One Peripherals

Interface/Connection	Connection	Integrated directly into head unit.
Power	Voltage (typical)	5 VDC +/- 10%, 50mV ripple max
	Current consumption (typical)	40mA max
Drivers	Windows native, OPOS, JPOS	
Operating Systems	Compatibility	Windows Windows 10 IoT Enterprise for Retail (64-bit)*, *** Windows 10 Pro (64-bit)*, ***

Temperature Range	Operational	0° C to 55° C
	Relative Humidity	90% (non-condensing)
Reliability	Operating Life	1,000,000 card swipes minimum
Agency Certifications	FCC, CE, USB-IF	
Country of Origin	Taiwan	

* Not all features are available in all editions or versions of Windows. Systems may require upgraded and/or separately purchased hardware, drivers, software or BIOS update to take full advantage of Windows functionality. Windows 10 is automatically updated, which is always enabled. ISP fees may apply and additional requirements may apply over time for updates. See <http://www.microsoft.com>

** Not all features are available in all editions of Windows. This system may require upgraded and/or separately purchased hardware to take full advantage of Windows functionality. See <http://www.microsoft.com>.

*** Full support on all x86-based Windows, NO current support drivers for ARM processor platforms.

**** The MSR designed into the Engage One terminal has an optional encryption functionality. HP has partnered with IDTECH Products to perform key injection services remotely. For more information about their service, contact the IDTECH Product sales team at Sales@idtechproducts.com.

HP Engage One Peripherals

HP Engage One 10.1" Touch Display



Models

HP Engage One 10.1 in Touch Display (Black)

1XD81AA

HP Engage One 10.1 in Touch Display (White)

3FH67AA

General

Display Size (diagonal) 10.1 in

HP Engage One Peripherals

Display Type	IPS w/LED backlight
Color	Ebony Black or Ceramic White
Input Connectors	USB-C (Upstream) (5 Gbits/sec, 5V/3A, Alt mode)
Native Resolution	1280 x 800 @ 60 Hz
Aspect Ratio	16:10
Brightness	500 cd/m ²
Static Contrast Ratio - Typical	800:1
Dynamic Contrast Ratio (DCR)	N/A
Pixel Pitch	0.1695 (H) x 0.1695 mm(V)
Pixels Per Inch (PPI)	149
Backlight Lamp Life	50k minimum
Anti-Glare Panel	Yes
BrightView Panel	No
Response Time	25ms
Color Gamut	45%
Color Support	Up to up to 16.1 million colors
Horizontal Viewing Angle (typical CR>10)	170°
Vertical Viewing Angle (typical CR>10)	170°
3D Vertical Viewing Angle	N/A

HP Engage One Peripherals

Panel Active Area 216.96 (H) x 135.60 (V)

Preset Graphic Modes/Supported Resolutions
 640 x 480 @ 60Hz
 800 x 600 @ 60 Hz
 1024 x 768 @ 60 Hz
 1280 x 720 @ 60 Hz
 1280 x 800 @ 60 Hz

Maximum Resolution 1280 x 800@ 60 Hz

Recommended Resolution 1280 x 800 @ 60 Hz

Vertical Scan Range 50 - 60 Hz

Horizontal Scan Range 30~54 kHz

Default Color Temperature Neutral (6500)

Maximum Pixel Clock Speed 110 MHz

Exterior Color of Monitor Bezel and Stand Black in bezel and hinge

Plug & Play Yes

Tilt 15 to + 90 degrees

Swivel No

Pivot No

Security Lock Ready No

Height Adjustment No

Height Adjustment Range (Min-Max) N/A

Detachable Base No

Warranty 3/3/0 : WW

Webcam N/A

Speakers Output Power N/A

VESA Mounting Yes

Touch Specifications **Touch Panel Type** Projective Capacitive 5 point

Positional Accuracy AA : ±0.1mm
 VA : ±1.5mm

Resolution Accuracy 16384*9600

HP Engage One Peripherals

	Optical Light Transmission (per ASTM D1003)	Normal Glass: T% \geq 85%
	Electrostatic Projection (pr EN6100-4-2, 1955)	IC : Air +/- 8 KV
On Screen Display (OSD)	On Screen Display User Controls	Brightness, Contrast, Color Control, Input Control, Image Control, Power Control, Menu Control, Management, Language, Information, Exit
	User Programmable Modes	Yes, 10
	Monitor Control Buttons or Switches	Menu/OK, Minus button/Down/Information, Plus button/Up/Color Control, Exit/Back/Brightness, Power
	Audio Controls	N/A
	Languages	10 (English, Spanish, German, French, Italian, Netherlands, Portuguese, Japanese, T-Chinese and S-Chinese)
Power	Power Supply	No
	Power Source	USB-C 5V/3A,15W
	Power Consumption - Maximum	15w
	Energy Saving/Standby Mode	0.5w
	Power Consumption - Typical	12w
	Power Cable Length	N/A
	Operational Mode at 100 VAC	20.72KHw/year
Operational Mode at 115 VAC	20.72KHw/year	
Operational Mode at 230 VAC	20.72KHw/year	
Operating Conditions	Operating Temperature	5° - 35°C 41° - 95°F
	Non-operating Temperature	- 20° - 60°C 29° - 140°F
	Operating Humidity	20% - 80% (non-condensing)
	Non-operating Humidity	5% - 95%
	Operating Altitude	0 - 5,000 m (16,400 ft.)
	Non-operating Altitude	0 - 12.192 m (40,000 ft.)

HP Engage One Peripherals

Dimensions	Unpacked without stand	9.69 x 6.07 x 1.38 in 24.62 x 17.02 x 3.52cm	
	Packed	12.05 x 4.33 x 9.13 in 30.6 x 11 x 23.2cm	
	Display Head Dimensions (Unpacked without stand)	9.69 x 6.07 x 0.59 in 24.62 x 17.02 x 1.5cm	
	Base Area Footprint	4.72 x 7.09in 119.98 x 179.97mm	
	Bezel Measurements	top 0.063 in, side 0.063 in, bottom 0.063in top 1.6 mm, side 1.6mm, bottom 1.6 mm	
	Weight (unpacked with stand)	3.3lb (1.49kg)	
	Weight (packed)	4.26lb(single pack) 1.93kg(single pack) 23.51lb(bulk pack) 10.67kg(bulk pack)	
	Environmental	Mercury-free display backlighting	Yes, Mercury-free LED backlighting
		Arsenic-Free Display Glass	Yes
		Low Halogen	Yes
Agency Approvals and Certifications		WW application CE/CB/MSIP/Mexico CoC/ICES/ISO 9241-307/ EAC/cTUVus/CCC/TUV-Barunt /VCCI/FCC/RCM/BSMI/WEEE/Ukraine/Morocco	
Microsoft WHQL Certification		Win-7, 8, 10	
China Energy Label		N/A	
TCO Certified Edge		No	
TCO Certified		No	
SmartWay Transport Partnership		Yes (NA SKU)	
Contains Recycled Plastics in Back Cover		85%	
Contains Recycled Plastics in Base/Stand	85%		
Contains Recycled Plastics in Other Parts	85% (Deco, Middle Frame)		
Recyclable Plastics	All		
Recyclable Packaging	All		
Software	N/A		
What's in the Box	Captive USB TYPE C cable (1.8m) and stand (15 to +90°)		
Options	The Engage One POS VESA Plate – 2WY48AA		

HP Engage One Peripherals

Country of Origin China

HP Engage One Peripherals

HP Engage One 10.1" Display

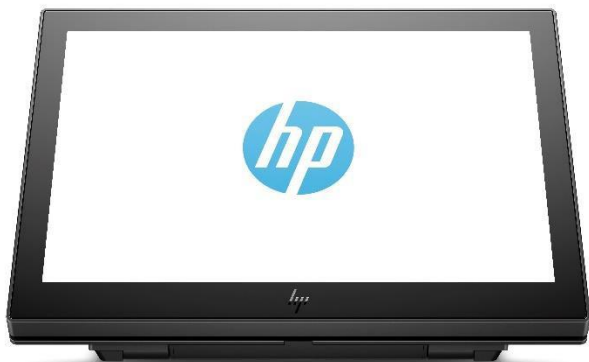

Models

HP Engage One 10.1 in Display (Black)

1XD80AA

HP Engage One 10.1 in Display (White)

3FH66AA

General

Display Size (diagonal) 10.1 in

Display Type IPS w/LED backlight

HP Engage One Peripherals

Color	Ebony Black or Ceramic White
Input Connectors	USB-C (Upstream) (5 Gbits/sec, 5V/3A, Alt mode)
Native Resolution	1280 x 800 @ 60 Hz
Aspect Ratio	16:10
Brightness	500 cd/m ²
Static Contrast Ratio - Typical	800:1
Dynamic Contrast Ratio (DCR)	N/A
Pixel Pitch	0.1695 (H) x 0.1695 mm(V)
Pixels Per Inch (PPI)	149
Backlight Lamp Life	50k minimum
Anti-Glare Panel	Yes
BrightView Panel	No
Response Time	25ms
Color Gamut	45%
Color Support	Up to up to 16.1 million colors
Horizontal Viewing Angle (typical CR>10)	170°
Vertical Viewing Angle (typical CR>10)	170°
3D Vertical Viewing Angle	N/A
Panel Active Area	216.96 (H) x 135.60 (V)

HP Engage One Peripherals

Preset Graphic Modes/Supported Resolutions	640 x 480 @ 60Hz 800 x 600 @ 60 Hz 1024 x 768 @ 60 Hz 1280 x 720 @ 60 Hz 1280 x 800 @ 60 Hz
Maximum Resolution	1280 x 800@ 60 Hz
Recommended Resolution	1280 x 800 @ 60 Hz
Vertical Scan Range	50 - 60 Hz
Horizontal Scan Range	30~54 kHz
Default Color Temperature	Neutral (6500)
Maximum Pixel Clock Speed	110 MHz
Exterior Color of Monitor Bezel and Stand	Black in bezel and hinge
Plug & Play	Yes
Tilt	15 to + 90 degrees
Swivel	No
Pivot	No
Security Lock Ready	No
Height Adjustment	No
Height Adjustment Range (Min-Max)	N/A
Detachable Base	No
Warranty	3/3/0 : WW
Webcam	N/A
Speakers Output Power	N/A
VESA Mounting	Yes
On Screen Display (OSD) On Screen Display User Controls User Programmable Modes Monitor Control Buttons or Switches	Brightness, Contrast, Color Control, Input Control, Image Control, Power Control. Menu Control. Management. Language. Information. Exit Yes, 10 Menu/OK, Minus button/Down/Information, Plus button/Up/Color Control, Exit/Back/Brightness, Power

HP Engage One Peripherals

	Audio Controls	N/A
	Languages	10 (English, Spanish, German, French, Italian, Netherlands, Portuguese, Japanese, T-Chinese and S-Chinese)
Power	Power Supply	No
	Power Source	USB-C 5V/3A,15W
	Power Consumption - Maximum	15w
	Energy Saving/Standby Mode	0.5w
	Power Consumption - Typical	12w
	Power Cable Length	N/A
	Operational Mode at 100 VAC	18.01KWh/year
	Operational Mode at 115 VAC	18.01KWh/year
	Operational Mode at 230 VAC	18.01KWh/year
	Operating Conditions	Operating Temperature
Non-operating Temperature		- 20° - 60°C 29° - 140°F
Operating Humidity		20% - 80% (non-condensing)
Non-operating Humidity		5% - 95%
Operating Altitude		0 - 5,000 m (16,400 ft.)
Non-operating Altitude		0 - 12.192 m (40,000 ft.)
Dimensions		Unpacked without stand
	Packed	12.05 x 4.33 x 9.13 in 30.6 x 11 x 23.2cm
	Display Head Dimensions (Unpacked without stand)	9.69 x 6.07 x 0.59 in 24.62 x 17.02 x 1.5cm
	Base Area Footprint	4.72 x 7.09in 119.98 x 179.97mm
	Bezel Measurements	top 0.063 in, side 0.063 in, bottom 0.063in top 1.6 mm, side 1.6mm, bottom 1.6 mm
	Weight (unpacked with stand)	3.3lb (1.49kg)
	Weight (packed)	4.26lb(single pack) 1.93kg(single pack) 23.51lb(bulk pack) 10.67kg(bulk pack)

HP Engage One Peripherals

Environmental	Mercury-free display backlighting	Yes, Mercury-free LED backlighting
	Arsenic-Free Display Glass	Yes
	Low Halogen	Yes
	Agency Approvals and Certifications	WW application CE/CB/MSIP/Mexico CoC/ICES/ISO 9241-307/ EAC/cTUVus/CCC/TUV-Barunt /VCCI/FCC/RCM/BSMI/WEEE/Ukraine/Morocco
	Microsoft WHQL Certification	Win-7, 8, 10
	China Energy Label	N/A
	TCO Certified Edge	No
	TCO Certified	No
	SmartWay Transport Partnership	Yes (NA SKU)
	Contains Recycled Plastics in Back Cover	85%
	Contains Recycled Plastics in Base/Stand	85%
	Contains Recycled Plastics in Other Parts	85% (Deco, Middle Frame)
	Recyclable Plastics	All
	Recyclable Packaging	All
Software	N/A	
What's in the Box	Captive USB TYPE C cable (1.8m) and stand (15 to +90°)	
Options	The Engage One POS VESA Plate – 2WY48AA	
Country of Origin	China	

HP Engage One Peripherals

HP Engage One Hub Mount

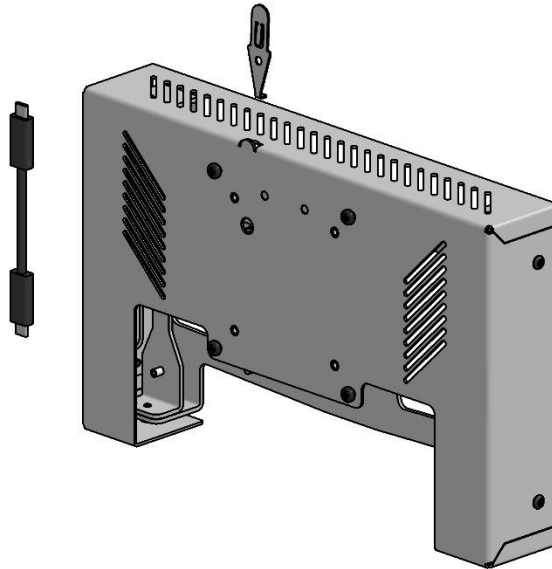

Model

HP Engage One Hub Mount

73X09AA

Introduction

The HP Engage One Hub Mount pairs together the HP Engage One AiO and a choice of the Basic or Advanced I/O Connectivity Hub into a single unit that can be attached to any compatible 75/100 VESA mounting.

General	Color	Black
	Dimensions (L x W x H)	305 mm x 193 mm x 52 mm (12.01 in x 7.60 in x 2.05 in)
	Weight	1.69 kg (3.73 lb)
	Box contents	Engage One Hub Mount and USB-C 430mm, male/ male cable (black)

Cable Routing Configurations

Engage One cable matrix with integrated column printer and basic I/O connectivity base

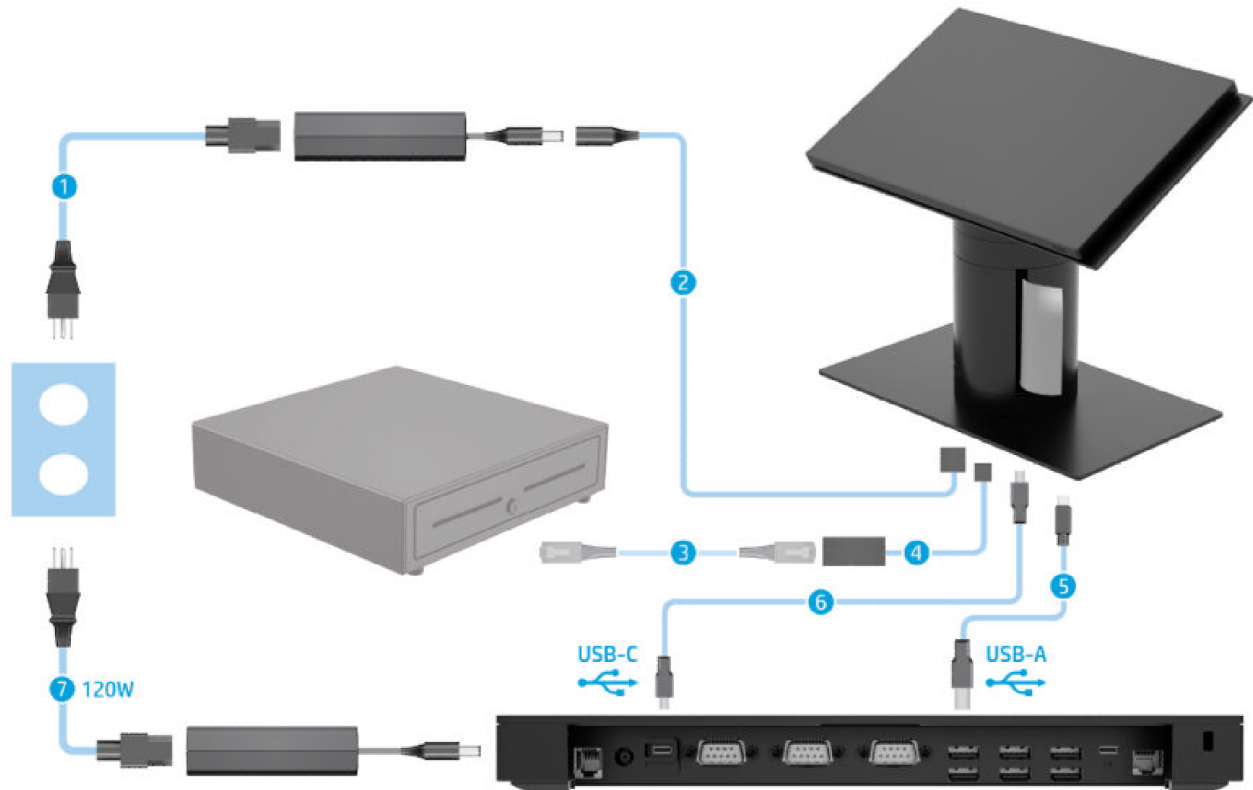

Cables

1. Column printer power adapter cord
2. Column printer power cable
3. Cash drawer cable (purchased separately with cash drawer)
4. Column printer cash drawer cable
5. I/O connectivity base mini USB Type-B to USB Type-A data cable
6. I/O connectivity base USB Type-C™ cable connect to the Head unit
7. I/O connectivity base 120 W power adapter cord

Cable Routing Configurations

Engage One cable matrix with integrated column printer and advanced I/O connectivity base

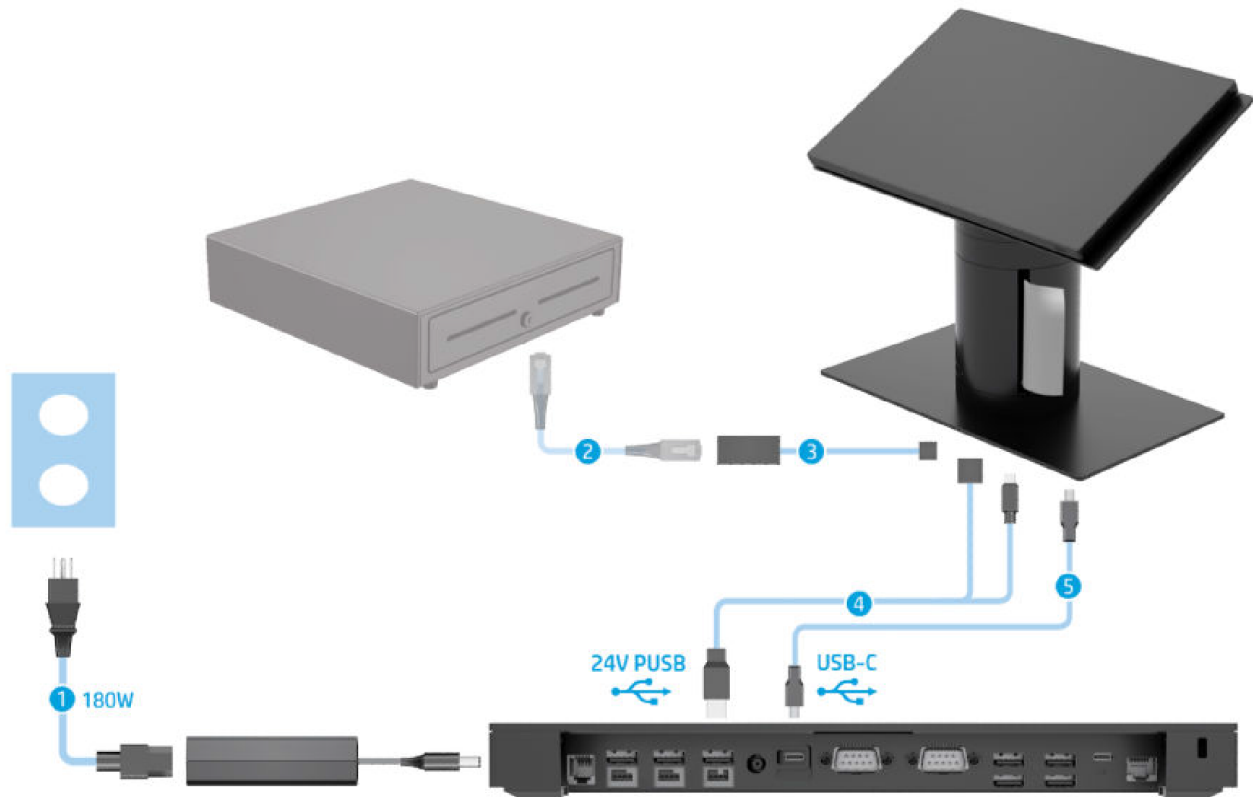

Cables

1. I/O connectivity base 180 W power adapter cord
2. Cash drawer cable (purchased separately with cash drawer)
3. Column printer cash drawer cable
4. Column printer 24 V PUSB power and data "Y" cable
5. I/O connectivity base USB Type-C™ cable connect to the Head unit

Cable Routing Configurations

Engage One cable matrix without I/O connectivity base

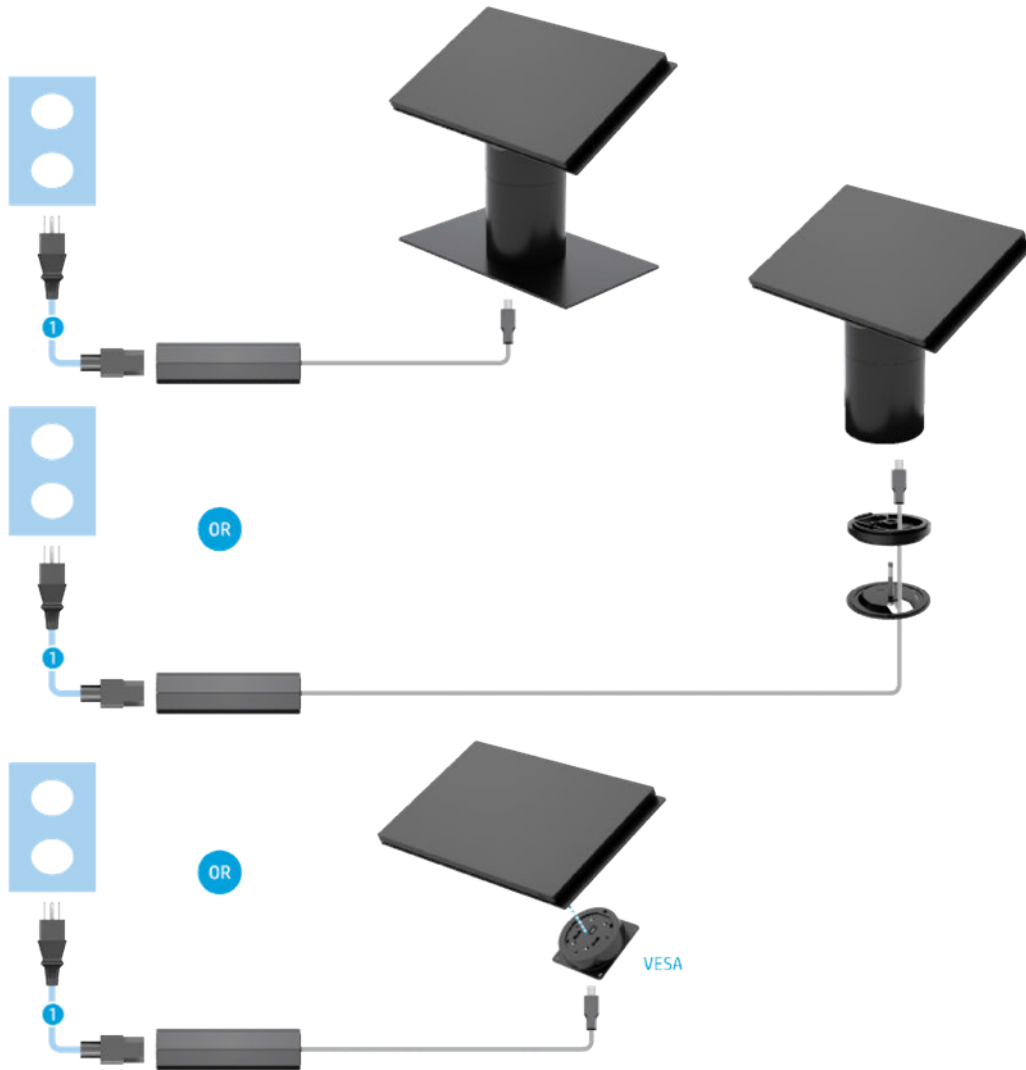

Cables

1. Power adapter cord

Cable Routing Configurations

Engage One cable matrix with I/O connectivity base and without printer

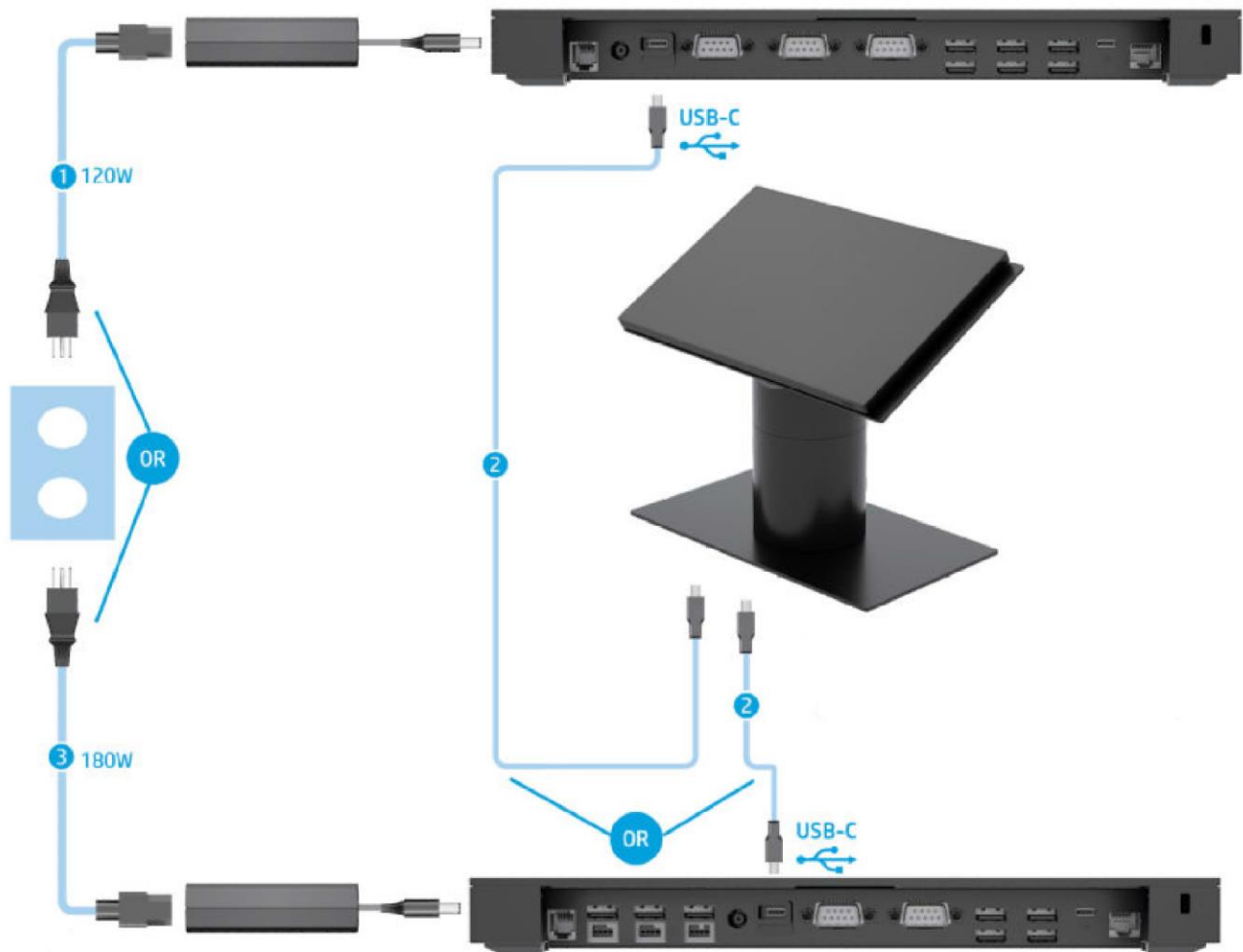

Cables

1. Basic I/O connectivity base 120 W AC power adapter cord
2. I/O connectivity base USB Type-C™ cable connect to the Head unit
3. Advanced I/O connectivity base 180 W AC power adapter cord

Cable Routing Configurations

Engage One cable matrix with basic I/O connectivity base and standalone printer

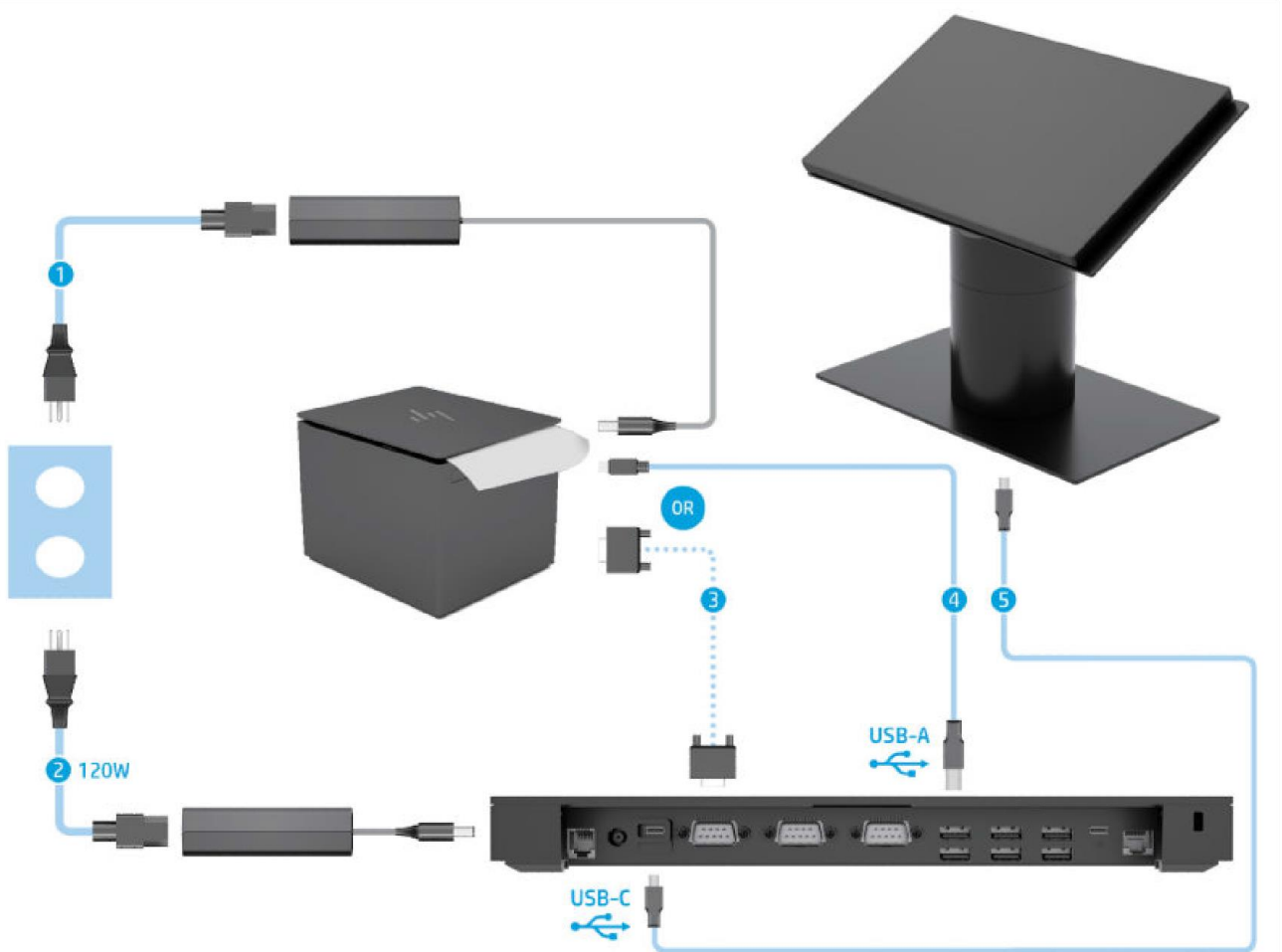

Cables

1. Printer power adapter cord
2. Basic I/O connectivity base 120 W AC power adapter cord
3. Printer serial data cable
4. Printer USB Type-A data cable
5. Basic I/O connectivity base USB Type-C™ cable connect to the Head unit

IMPORTANT: Connect either the serial data cable (3) or the USB Type-A data cable (4) between the I/O connectivity base and the printer. Do not connect both.

Cable Routing Configurations

Engage One cable matrix with advanced I/O connectivity base and standalone printer

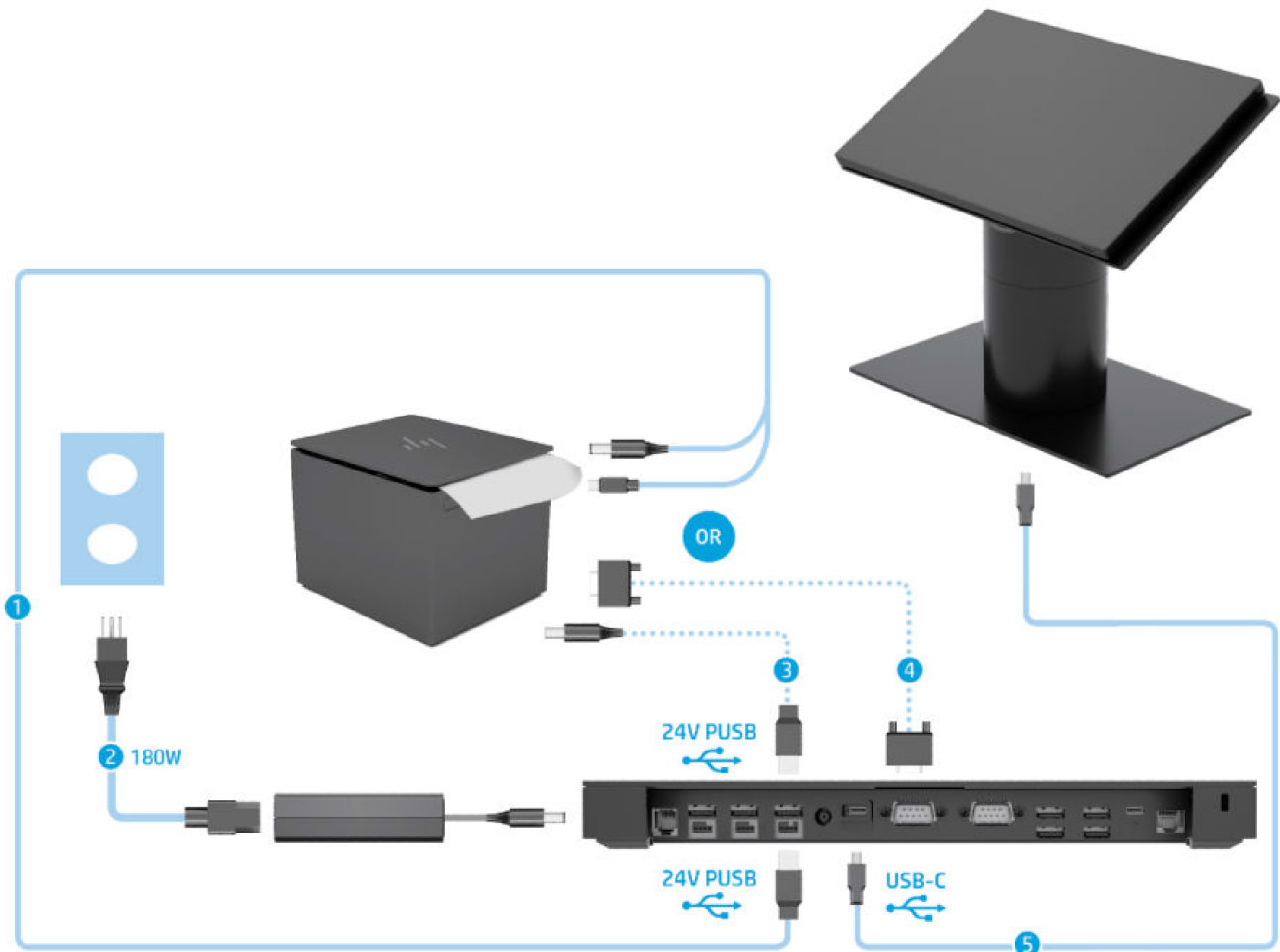

Cables

1. Printer 24 V PUSB power and data “Y” cable
2. Advanced I/O connectivity base 180 W AC power adapter cord
3. Printer 24 V PUSB power cable
4. Printer serial data cable
5. Advanced I/O connectivity base USB Type-C™ cable connect to the Head unit

IMPORTANT: Connect either the 24 V PUSB power and data “Y” cable (1) or the 24 V PUSB power cable (3) and serial data cable (4) between the I/O connectivity base and the printer. Do not connect both.

Engage One Accessories

Connectivity Bases

HP Engage One Advanced I/O Connectivity Base*
HP Engage One Basic I/O Connectivity Base

Part Number

1UN12AA
1UN11AA

Printers

HP Engage One Serial USB Thermal Printer
HP PUSB Thermal Receipt Printer
HP Serial USB Thermal Receipt Printer
HP Value PUSB Receipt Printer
Epson TMT88V PUSB Thermal Receipt Printer
Epson TMT88V Serial USB Thermal Receipt Printer

1RL96AA
FK224AA
BM476AA
F7M67AA
E1Q93AA
D9Z52AA

Integrated Peripherals

HP Engage One Fingerprint Reader
HP Engage One Top Mount 2x20 CFD

1RL98AA
1RL95AA

Customer Facing Displays and Display Options

HP Engage One 10.1in Touch Display*
HP Engage One 10.1in Non-Touch Display*

1XD81AA
1XD80AA

Pole Displays

HP POS Pole Display

FK225AA

*Available November 2017

Engage One Accessories

Cable kits for stand alone printer

	Part Number
HP Engage One Printer USB + Pwr Adptr	1RM02AA
HP Engage One Printer Serial + Pwr Adptr	1RM03AA
HP Engage One Printer PUSB Y Cable	BM477AA
HP Engage One Printer Serial + PUSB Pw only	1RM05AA
HP Engage One W Printer USB + Pwr Adptr	3WV53AA
HP Engage One W Printer Serial + Pwr Adptr	3WV54AA
HP Engage One W Printer PUSB Y Cable	3WV55AA
HP Engage One W Printer Serial + PUSB Pw only	5FW23AA

Graphics Video Adapters & Cables

HP Type-C™ to DisplayPort Adapter	N9K78AA
HP Type-C™ to HDMI Adapter	N9K77AA
HP Type-C™ to VGA Adapter (Slice)	N9K76AA

IO Devices, I/O Adapters

HP USB to Serial Port Adapter (Win7/8/10)	J7B60AA
HP USB Business Slim Keyboard	N3R87AA
HP USB 1000dpi Laser Mouse	QY778AA
HP USB Hardened Mouse	P1N77AA
HP USB Optical 2.9M Mouse	Z3Q64AA
HP POS Keyboard	FK221AA
HP POS Keyboard with MSR	FK218AA
HP PUSB Y Cable	BM477AA
HP USB-C™ to RJ45 Adapter	V7W66UT

Hub Mount

HP Engage One Hub Mount	73X09AA
-------------------------	---------

Scanners

	Part Number
HP Engage One 2D Barcode Scanner	1RL97AA
HP Wireless Barcode Scanner	E6P34AA

Cash Drawers

HP Flip Top Cash Drawer	BW867AA
HP Heavy Duty Cash Drawer	FK182AA
HP Standard Duty Cash Drawer	QT457AA

Engage One Accessories

HP USB Standard Duty Cash Drawer	E8E45AA
HP Standard Duty Till Insert w/ Lockable Lid	QT458AA
HP Cable Pack for Dual HP Cash Drawers	QT538AA

Summary of Changes

Date of change:	Version History:		Description of change:
August 16, 2017	From v1 to v2	Changed	Format on sections
August 25, 2017	From v2 to v3	Added	Notes about the Mounting bracket, BIOS support and the MSR, added Packaging Weights
		Changed	Format on sections
September 22, 2017	From v3 to v4	Changed	HP ElitePOS PUSB Y Cable part number to BM477AA. HP ElitePOS Printer PUSB Y Cable part number to BM477AA
October 19, 2017	From v4 to v5	Added	HP USB-C Mini Dock to base choices, Added specs for HP USB-C Mini Dock, Added Specs for ElitePOS Touch Display and ElitePOS Display
October 19, 2017	From v5 to v6	Added	The ElitePOS POS VESA Plate – 2WY48AA as an option for ElitePOS Touch Display and ElitePOS Display
January 14, 2018	From v6 to v7	Added	Part number for white models and color specs
January 26, 2018	From v7 to v8	Changed	System interface value to USB 3.0
June 25, 2018	From v8 to v9	Changed	USB section and vPRO disclaimer
August 1, 2018	From v9 to v10	Changed	Series name
August 8, 2018	From v10 to v11	Changed	Images
September 12, 2018	From v11 to v12	Added	Cable kits available for the HP Engage One Serial USB Thermal Printer (White)
October 31, 2018	From v12 to v13	Changed	Longevity and Upgrading section
August 1, 2019	From v13 to v14	Changed	Operating System section
August 22, 2019	From v14 to v15	Changed	Cable Routing Configurations
September 25, 2019	From v15 to v16	Added	HP USB-C to RJ45 Adapter to Accessories section
		Changed	TEMPERATURE, HUMIDITY, ALTITUDE section
October 9, 2019	From v16 to v17	Changed	At A Glance, HP Engage One Column Printer, HP Engage One Serial USB Thermal Printer, HP Engage One 10.1" Display, HP Engage One 10.1" Touch Display sections
January 24, 2020	From v17 to v18	Changed	Operating System section
June 26, 2020	From v18 to v19	Changed	Environmental Data section
July 15, 2020	From v19 to v20	Changed	Environmental Data section
October 15, 2020	From v20 to v21	Changed	Security section and changed Energy Star and EPEAT certifications
February 10, 2021	From v21 to v22	Changed	Engage One Accessories section
March 26, 2021	From v22 to v23	Changed	At A Glance section
July 22, 2021	From v23 to v24	Removed	SD card reader reference
October 13, 2021	From v24 to v25	Changed	HP Engage One 10.1" Display, HP Engage One 10.1" Touch Display sections
April 22, 2022	From v25 to v26	Changed	OPERATING SYSTEM section
May 2, 2022	From v26 to v27	Changed	POWER section
September 15, 2022	From v27 to v28	Added	HP Engage One Hub Mount to Engage One Accessories section
October 6, 2022	From v28 to v29	Added	HP Engage One Hub Mount specs
		Removed	HP Engage One Serial USB Thermal Printer
November 4, 2022	From v29 to v30	Removed	Android support
November 18, 2022	From v30 to v31	Added	Introduction information to the HP Engage One Hub Mount section

Copyright © 2022 HP Development Company, L.P.

All rights reserved. Microsoft, Windows, Windows 7, Windows 8, and Windows 10 are registered trademarks or trademarks of Microsoft Corporation in the U.S. and/or other countries. Intel®, Celeron®, Pentium® and Core™ are registered trademarks or trademarks of Intel Corporation in the U.S. and/or other countries. Linux is the registered trademark of Linus Torvalds in the U.S. and other countries. Bluetooth® is a registered trademark of its proprietor and used by HP Inc. under license. ENERGY STAR® is a registered trademark owned by the U.S. Environmental Protection Agency.

The information contained herein is subject to change without notice. The only warranties for HP products are set forth in the express limited warranty statements accompanying such products. Nothing herein should be construed as constituting an additional warranty. HP shall not be liable for technical or editorial errors or omissions contained herein.